



**SPECIALIST
MACHINERY
SALES**

AUSTRALIA, NEW ZEALAND & SE ASIA

THOUGHT-LEADER IN STEEL PROCESSING AUTOMATION

SUPERIOR MACHINERY SYSTEMS



1300 262 123 / +61 8 6500 6880



**tellmemore@smsales.com.au
www.SMSales.com.au**





MAXIMISE EFFICIENCY AND PRECISION WITH OUR COMPLETE STEEL PROCESSING SYSTEMS

At Specialist Machinery Sales, we take pride in being your one-stop system provider for all your manufacturing needs, from prefabrication to post-fabrication. As a leading provider of machinery and equipment, we offer a comprehensive range of solutions to streamline your production processes.

From state-of-the-art machinery for prefabrication, including cutting-edge sawing, drilling, and milling systems, to advanced technologies for post-fabrication, such as shotblasting and painting systems, we have you covered every step of the way.

Our goal is to provide you with a complete system that ensures efficiency, productivity, and exceptional quality throughout your manufacturing operations. With our expertise and industry-leading equipment, you can transform your traditional factory into a smart, modern facility capable of delivering superior results.

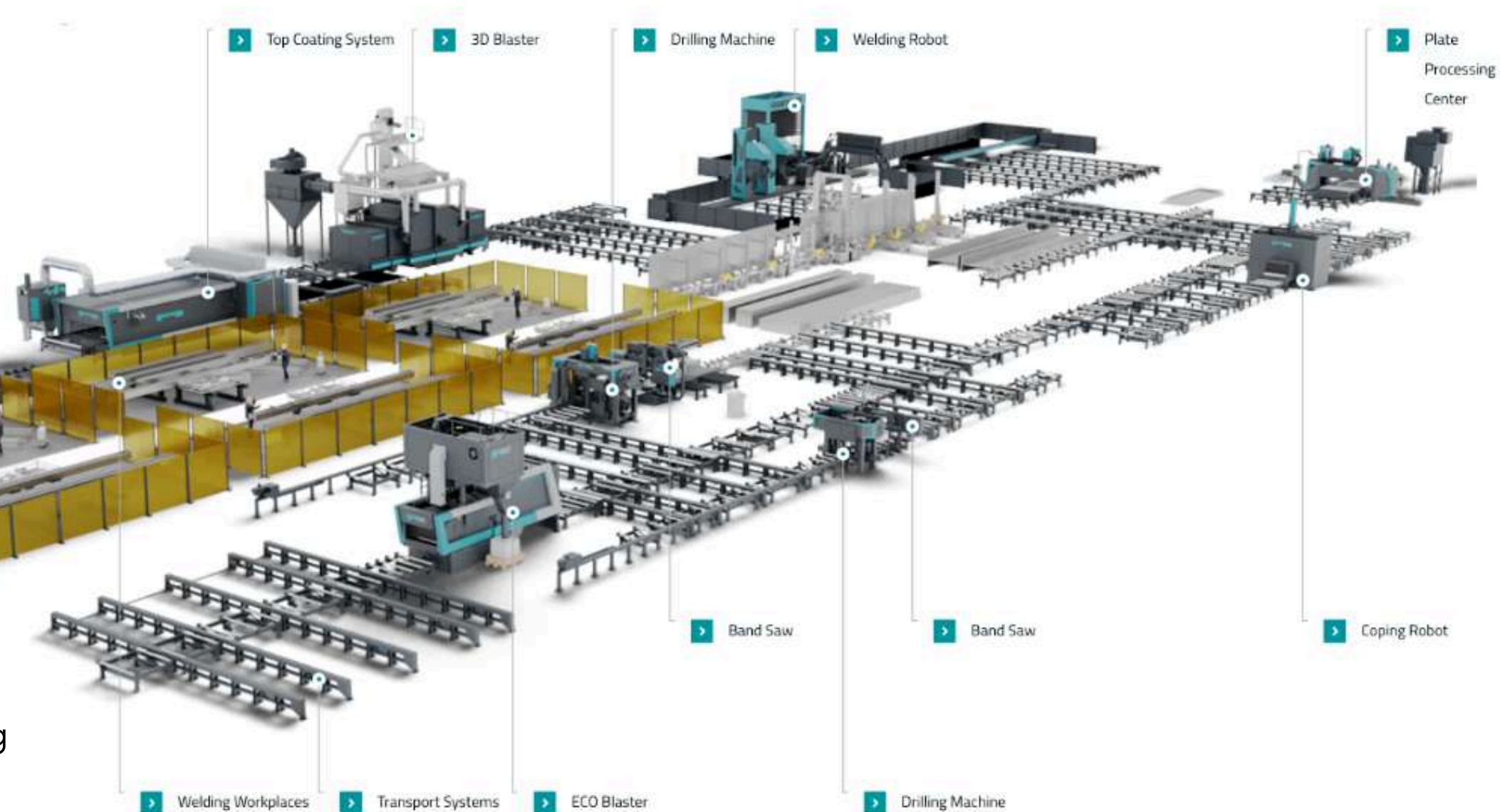

WHAT'S INSIDE:

OUR SUPERIOR MACHINERY SYSTEMS

Pre-fabrication / Steel Processing
Fabrication / Welding
Post-fabrication

OUR INDUSTRY SOLUTIONS

Steel Fabrication	Steel Service Centres
Metal Construction	Transmission Towers
Bridge Building	Crane Building
Structural Engineering	Automotive Sector

WHY PARTNER WITH SMS?

WHAT OUR CLIENTS SAY





**SPECIALIST
MACHINERY
SALES** AUSTRALIA, NEW ZEALAND & SE ASIA

YOUR MACHINERY OPTIONS



PRE-FABRICATION / STEEL PROCESSING

Specialist Machinery Sales (SMS) provides a wide range of prefabrication machinery designed to assemble steel components with precision and efficiency.

Our comprehensive selection includes bandsaws, beamlines, coping robots, plasma cutters, pipe rotators, and shotblasting machines. With our cutting-edge machines, you can streamline your steel fabrication process and ensure seamless on-site erection.

[LEARN MORE HERE ▶](#)





BANDSAW

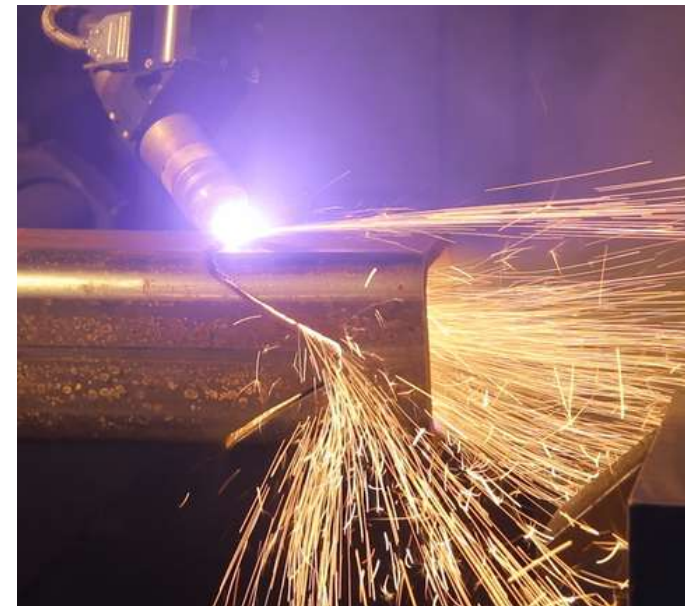

**BEAMLINER AND
COPING ROBOT**



CIRCULAR SAWING



**PLASMA AND LASER
CUTTING**



PIPE ROTATORS



PIPE WELDING



**PLATE AND SECTION
ROLLING / BENDING**

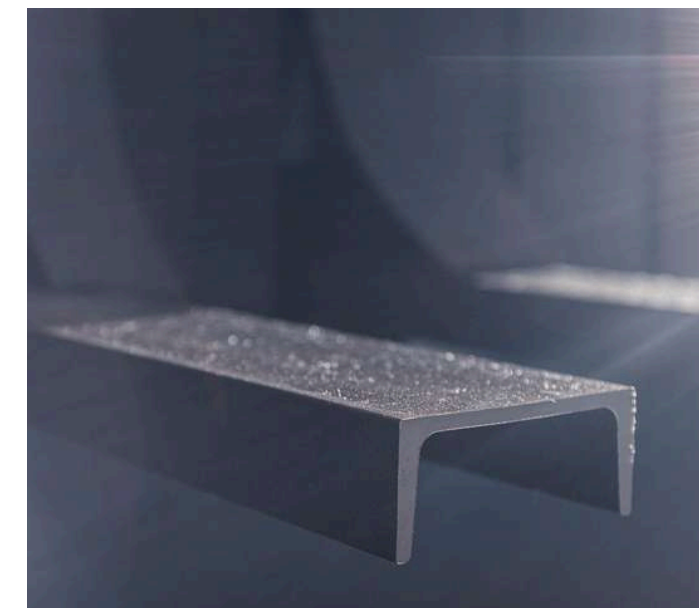

SHOT BLASTING

YOUR MACHINERY OPTIONS



FABRICATION / WELDING

Fabrication machinery plays a vital role in manufacturing steelwork components that form complete frames and structures. At Specialist Machinery Sales, we provide top-of-the-line machinery for beam/robot welding, steel beam assembly, and welding. With our high-caliber equipment, your workshop can achieve full automation, productivity, and efficiency.

Explore the options below to discover the range of machines that can elevate your fabrication processes to new heights.

[LEARN MORE HERE ►](#)



**SPECIALIST
MACHINERY
SALES**

AUSTRALIA, NEW ZEALAND & SE ASIA





**BEAM WELDING /
ROTATION**



**BEAM PROFILE LAYOUT
LASER MARKING**

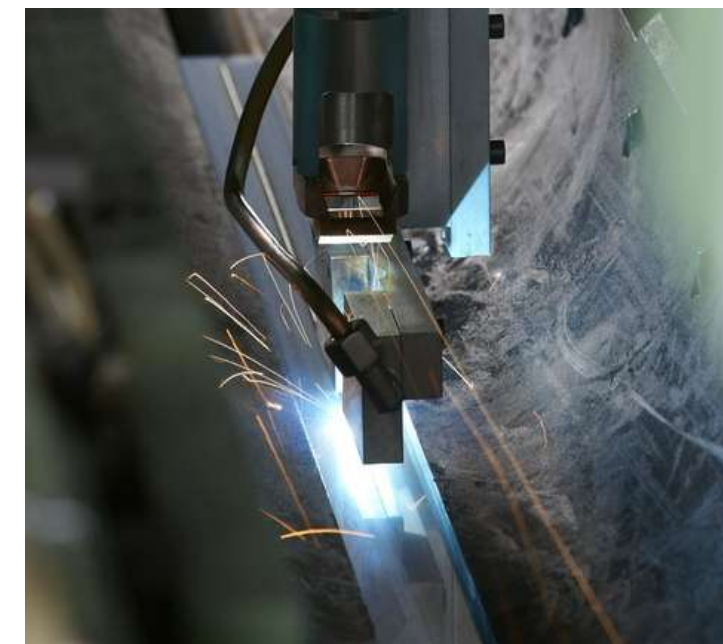

**PLATE
WELDING**



**LASER CLADDING /
WELDING / HARDENING**



**ROBOT
WELDING**



**ROBOTIC STRUCTURAL
STEEL ASSEMBLY**



**SPECIALIST
MACHINERY
SALES** AUSTRALIA, NEW ZEALAND & SE ASIA

YOUR MACHINERY OPTIONS



POST-FABRICATION

Post-fabrication is a crucial stage in ensuring the highest quality for steel structures. At Specialist Machinery Sales, we have partnered with renowned European brands specialising in shotblasting and painting systems, bringing you top-notch solutions.

Choose from a wide range of shotblasting and painting systems, powder coating systems, and zinc spraying systems from industry-leading brands like Kaltenbach and SLF. These cutting-edge technologies will enhance the durability, aesthetics, and overall performance of your steel structures. Take your fabrication process to the next level with our comprehensive post-fabrication solutions.

LEARN MORE HERE ▶





PAINTING SYSTEMS

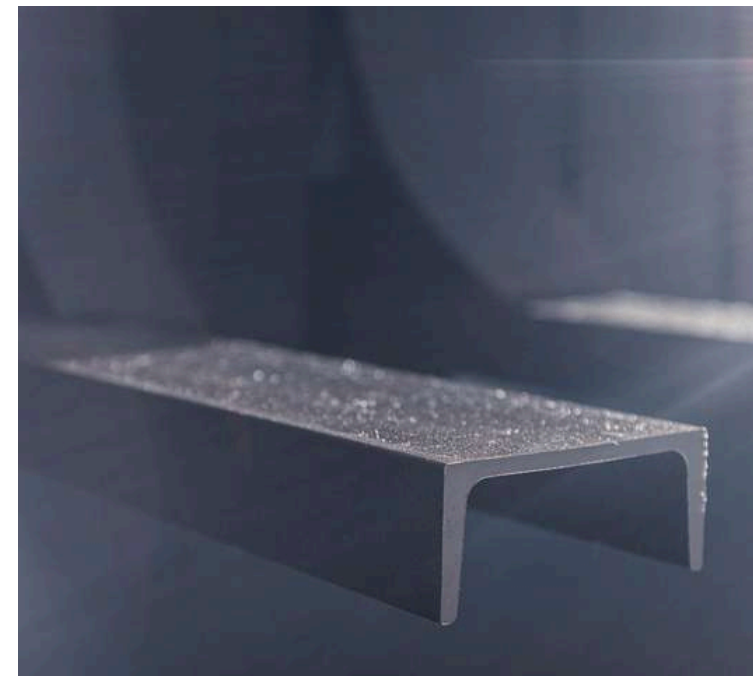

SHOT BLASTING



**SPECIALIST
MACHINERY
SALES** AUSTRALIA, NEW ZEALAND & SE ASIA

OUR INDUSTRY SOLUTIONS



Specialist Machinery Sales provides our clientele with a full range of structural steel machinery options for industries such as steel construction/fabrication and steel service centres.

Aside from these, we are proud to showcase a variety of steel processing machines for different sectors under the steel manufacturing industry like 5G Poles, Power Transmission Towers, Shipyards, Metal and Machine Construction, Bridge Building, Aviation, Agricultural Machine Engineering, and the Automotive sector, just to name a few.

[LEARN MORE HERE ▶](#)





STEEL FABRICATION

We offer cutting-edge solutions to upgrade your traditional factory into a smart and automated steel production facility.

From advanced blasting and painting processes to precise cutting and welding techniques, our technology-driven solutions will revolutionise your manufacturing capabilities.

Unlock the potential of efficiency, productivity, and quality in your steel production.

[LEARN MORE HERE ▶](#)

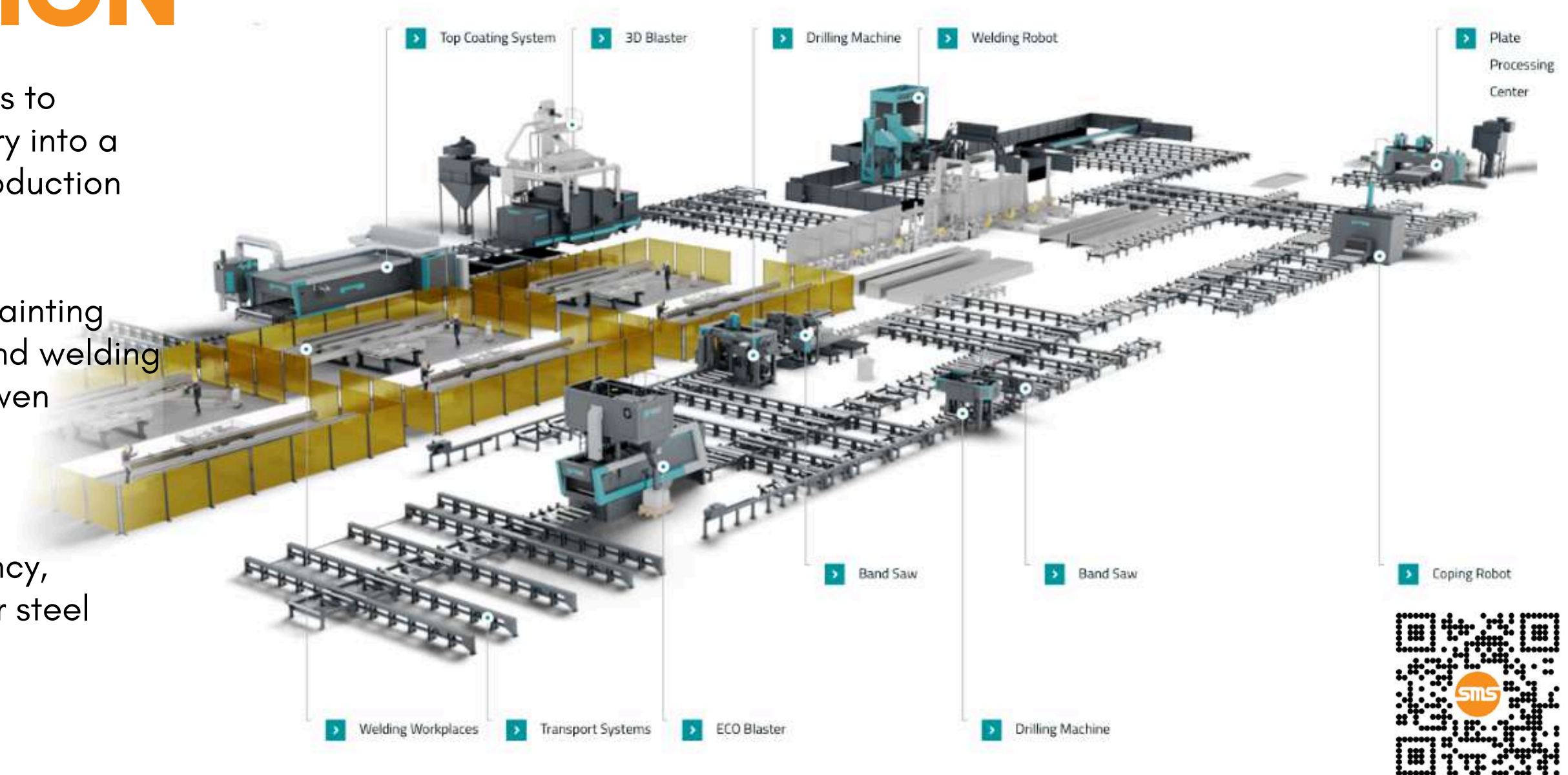



METAL CONSTRUCTION

Experience optimum flexibility in metal construction with our easy cutting capabilities for box sections, small profiles, and larger parts.

Our fast, precise, and comfortable sawing, combined with a high-performance drilling system, ensures efficient operations.

Count on us to find the perfect solution for your requirements, delivering safety, effectiveness, and reliability.

LEARN MORE HERE ▶

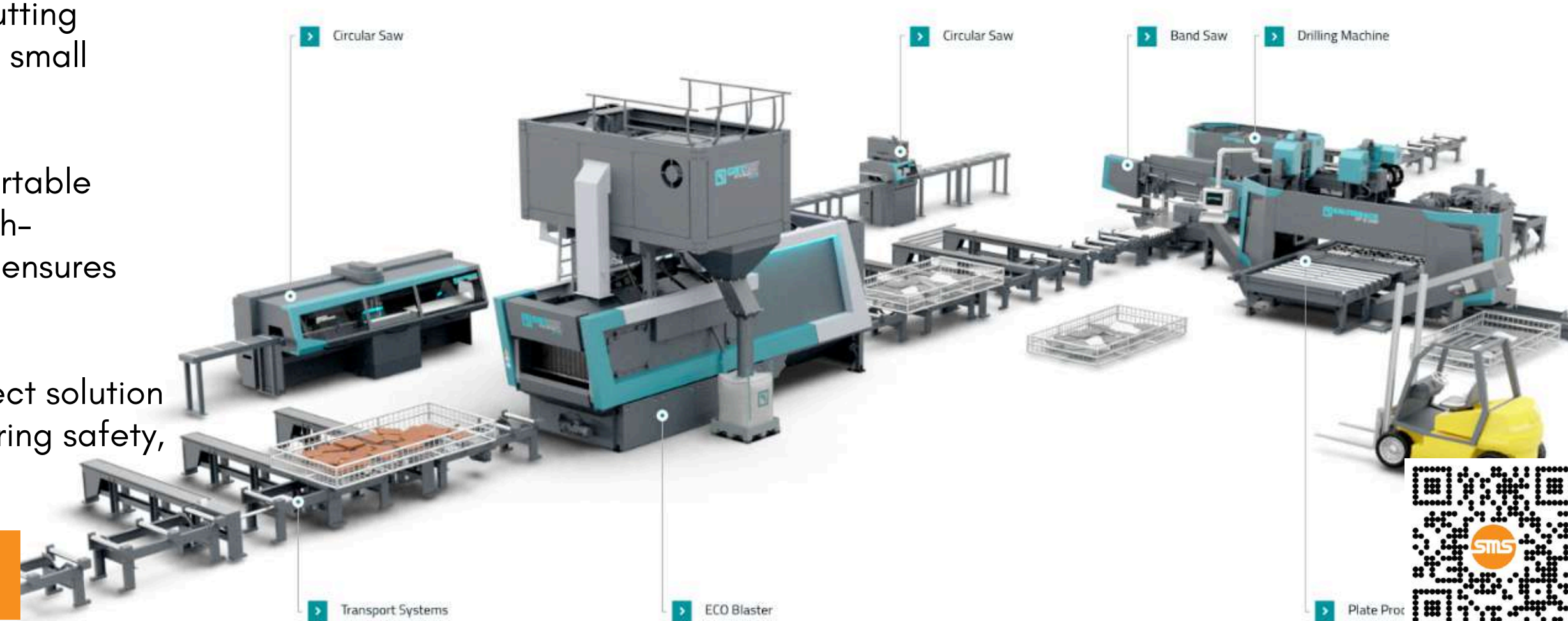



BRIDGE BUILDING

Experience the power of our unique machine combination for producing plates and profiles with precision holes and welding edges.

Our solution offers the highest efficiency and eco-friendly operation, enabling you to achieve the lowest cost of ownership. Take your production to the next level with us.

LEARN MORE HERE ▶

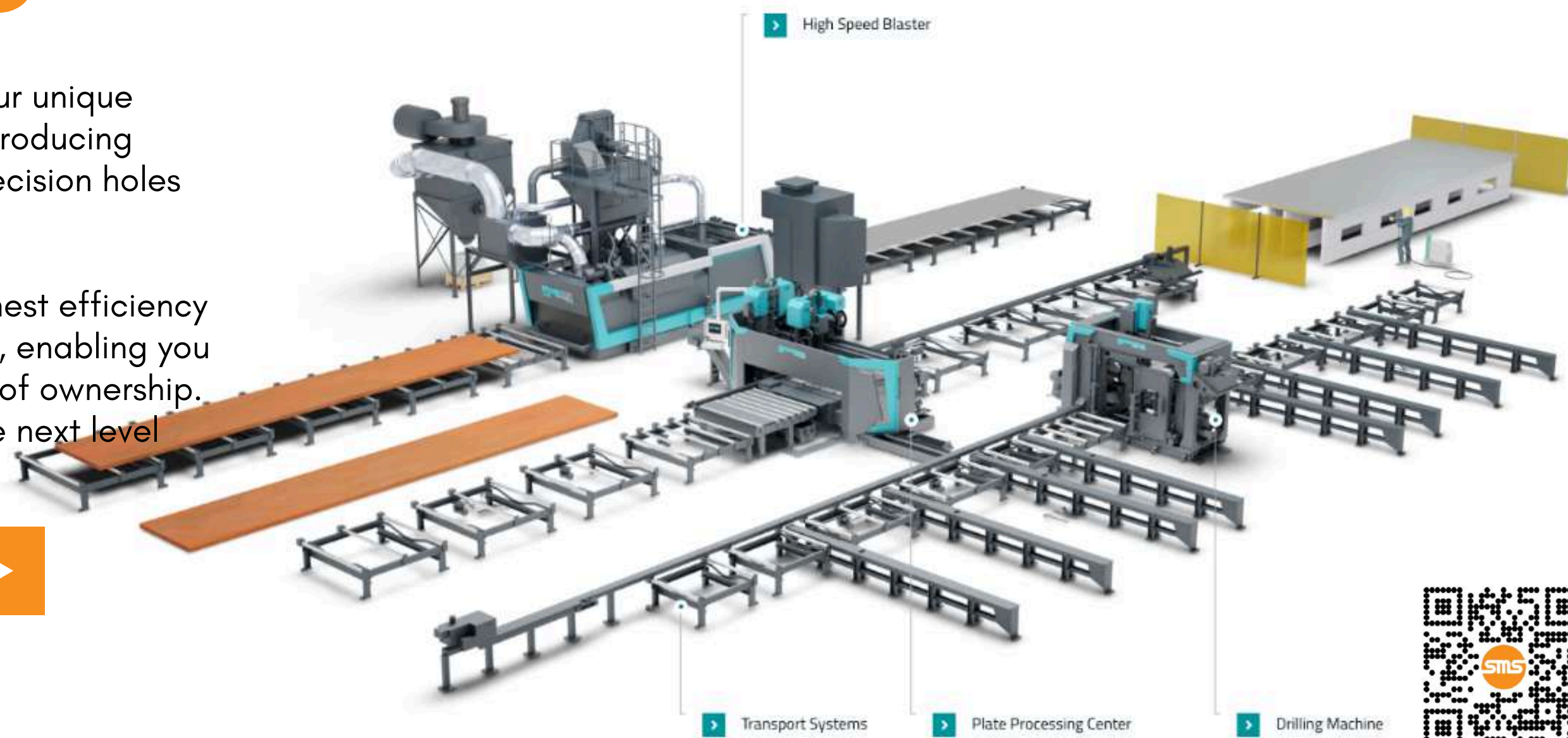



STRUCTURAL ENGINEERING

Our advanced line brings your designs to life with precision. From blasting to sawing, drilling, milling, cutting, and coping, we process single parts with utmost accuracy.

Effortlessly weld the parts together, and then experience exceptional end products through our cleaning and painting processes.

LEARN MORE HERE ▶

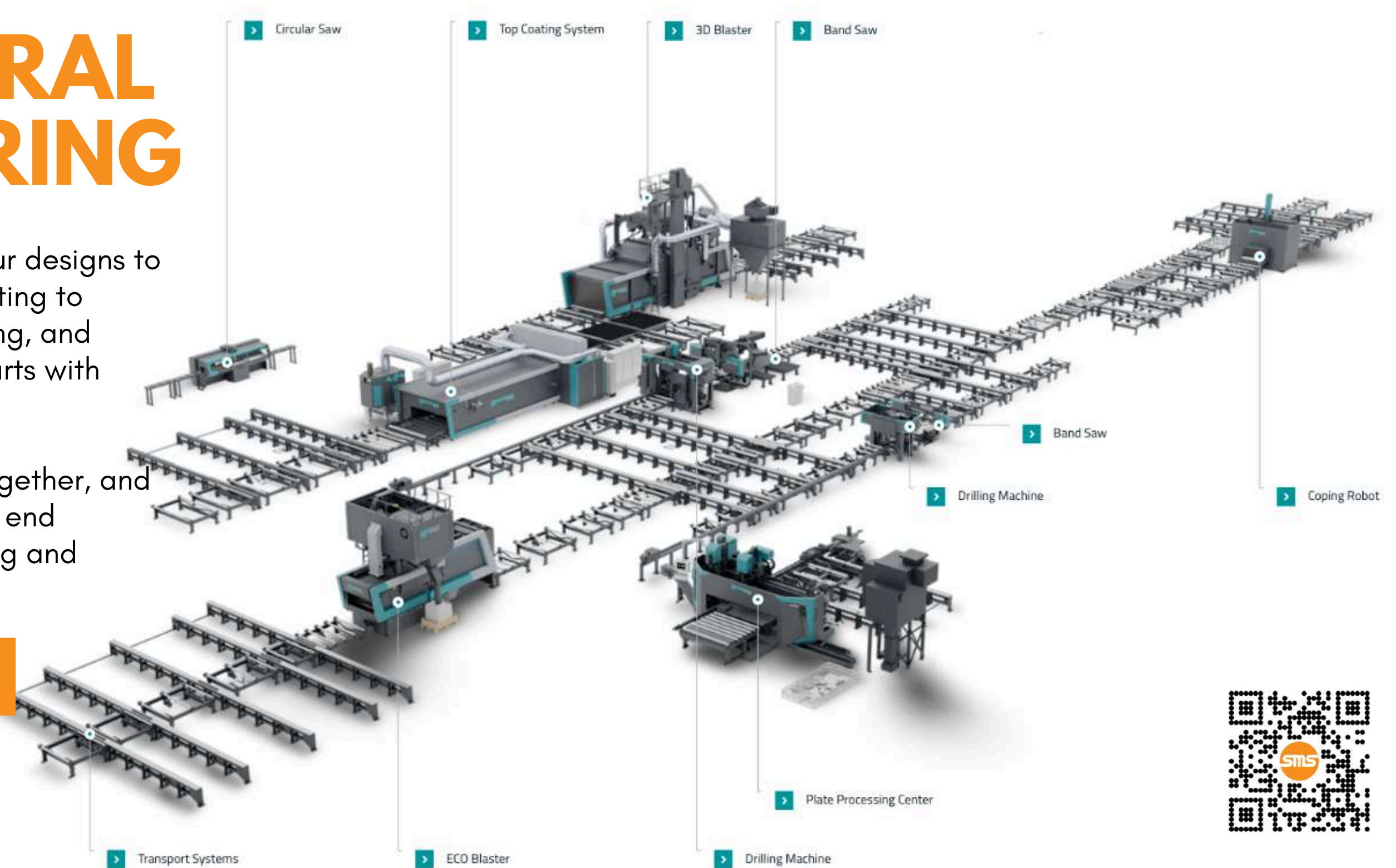



STEEL SERVICE CENTRES

Achieve success by leveraging the power of our machinery. With our automated solutions for sawing, drilling, milling, and coping, you'll enhance your business capabilities.

After precision processing, our shotblasting and painting techniques ensure a protected and impeccable surface finish. Experience the difference and take your business to new heights.

LEARN MORE HERE ▶

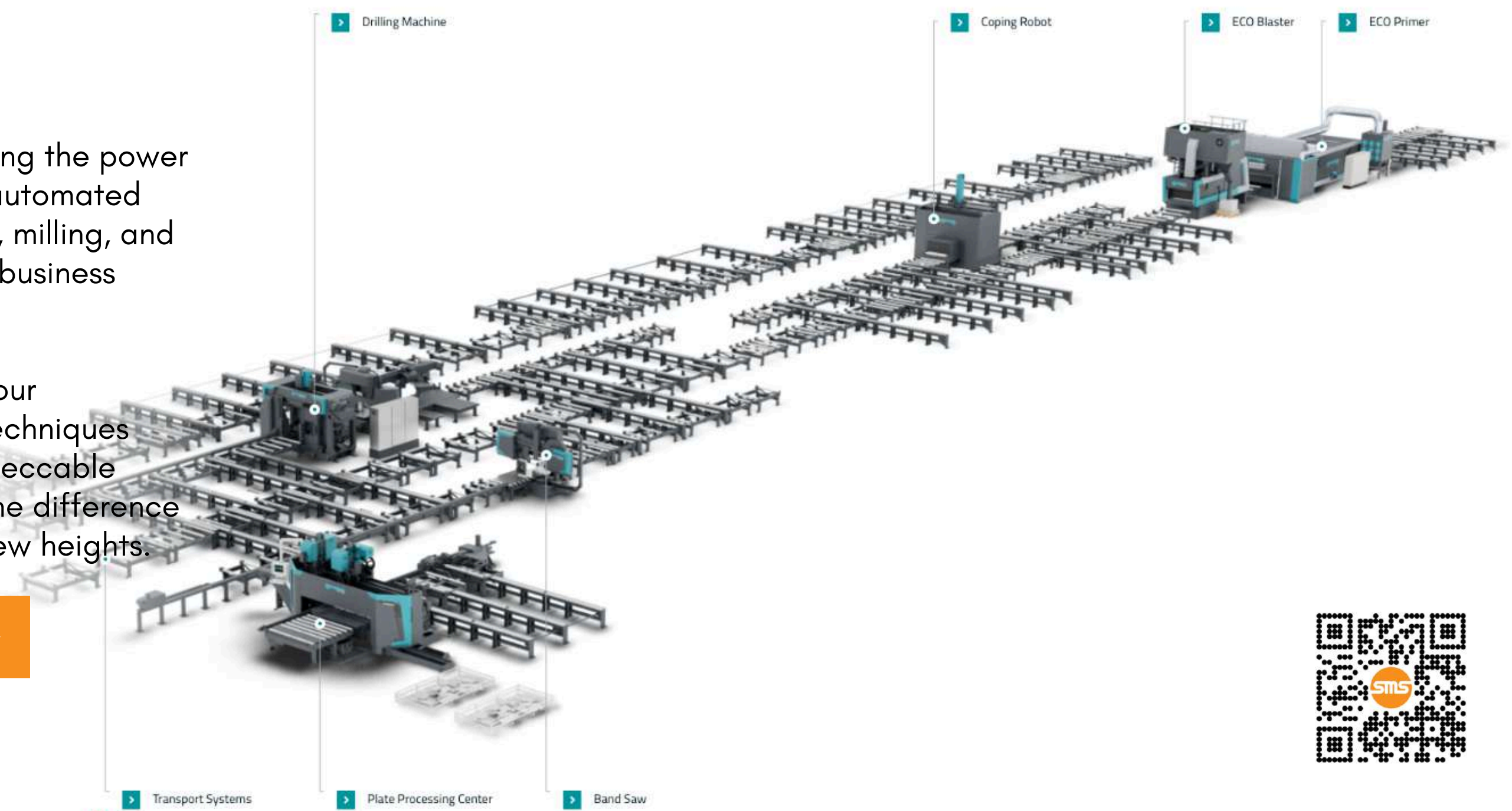



TRANSMISSION TOWERS

Need slot holes in your steel? Our drilling machine KDP, equipped with movable axes and 12 tools/axis, ensures fast and efficient milling of slotted holes.

Looking for multiple connection holes? Our KF 2628 with double drilling and plasma axis is designed to handle the production of numerous plate parts with ease.

Trust in our cutting-edge machinery to streamline your steel fabrication process and meet your exact specifications.

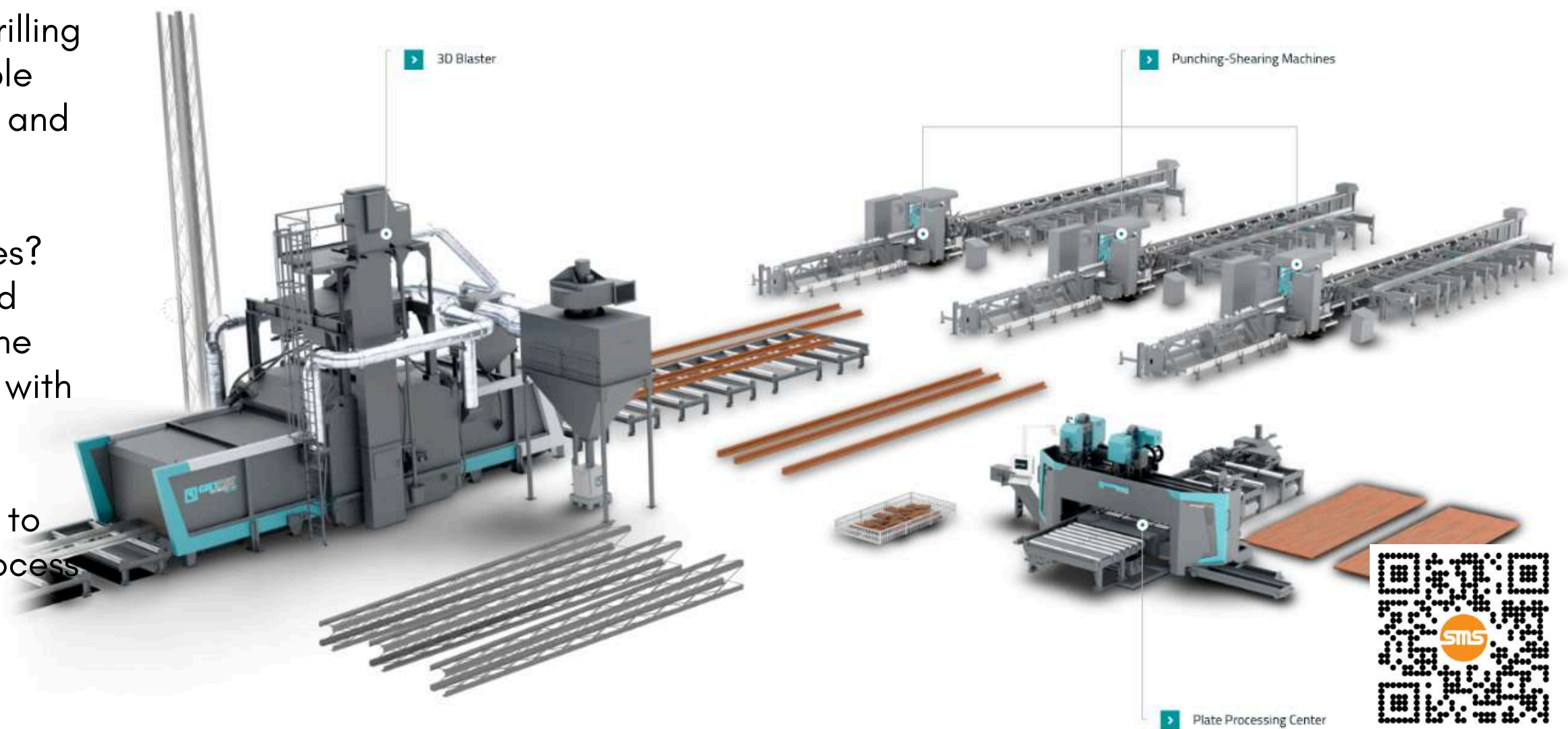

LEARN MORE HERE ▶



CRANE BUILDING

When it comes to steel processing, reliability, experience, and flexibility are paramount. That's why we offer top-of-the-line machinery specifically designed for the crane building sector.

With our solutions, you can ensure total protection against corrosion for steel structures, including surface preparation and coating.

[LEARN MORE HERE ▶](#)

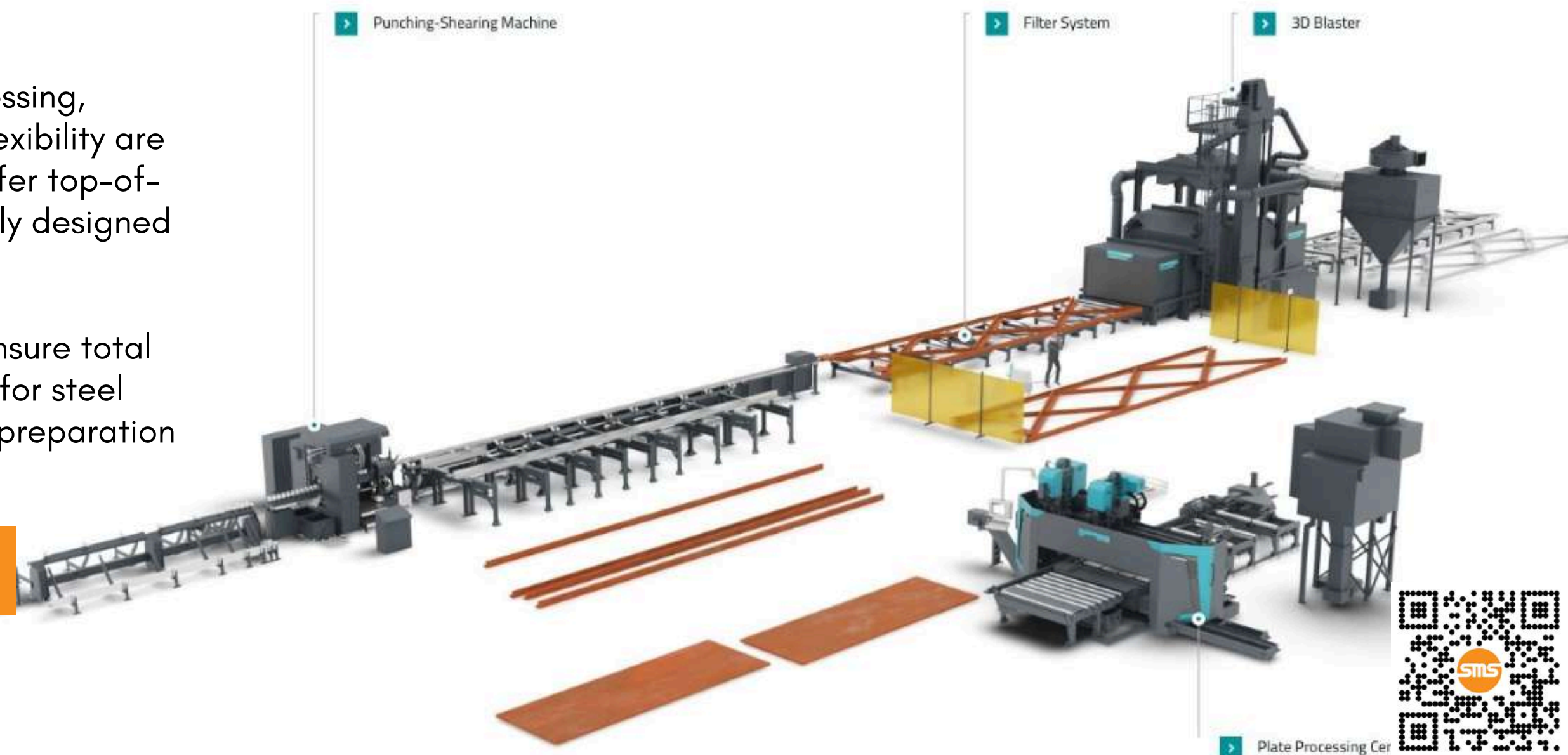



AUTOMOTIVE SECTOR

Experience high precision in automotive component manufacturing with our state-of-the-art machinery. Our advanced processes, including shotblasting, sawing, drilling, oxyfuel, and plasma cutting, are tailored to produce top-quality products.

Each item is meticulously crafted according to your specifications, complete with precise identification marks made by our scribing tool or hard stamp unit. Trust us to bring your drawings to life with perfection.

[LEARN MORE HERE ▶](#)

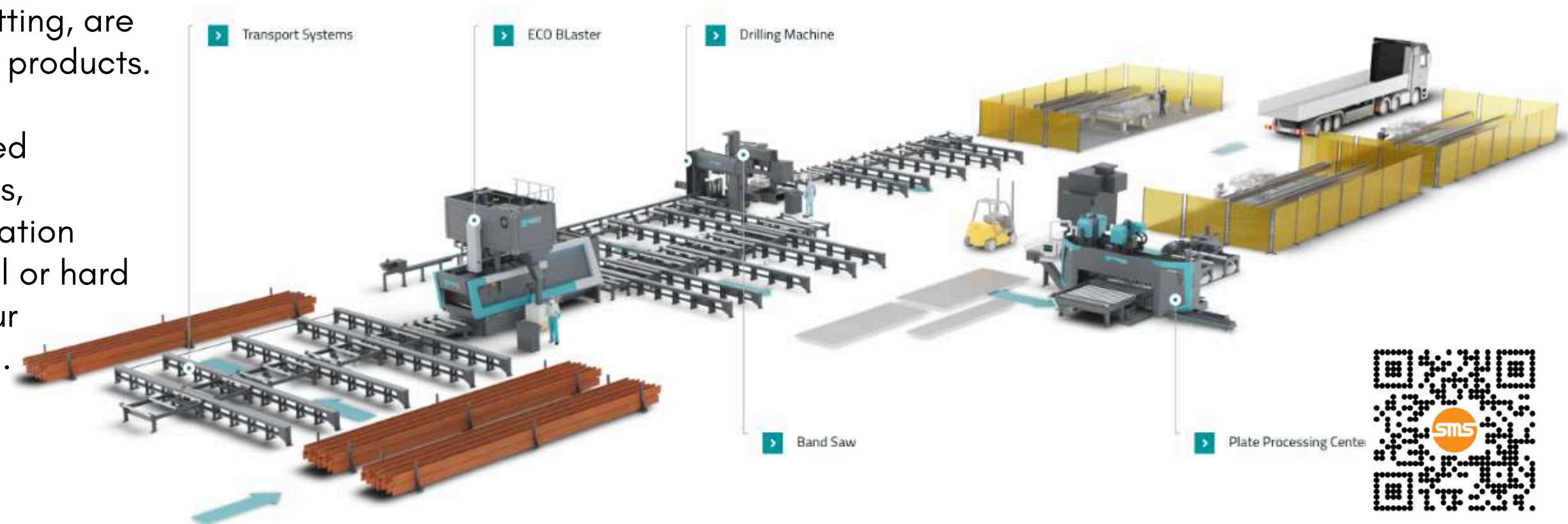



SHOT BLASTING AND PAINTING LINE

Achieve high blasting efficiency and reduce paint consumption with our cutting-edge combined systems. We prioritise cost-effectiveness in your production processes, offering the lowest overall cost without compromising on quality.

Our integrated systems are designed with durability, versatility, and user-friendliness in mind. Experience seamless operation, easy maintenance, and exceptional performance, ensuring maximum productivity and efficiency for your business.

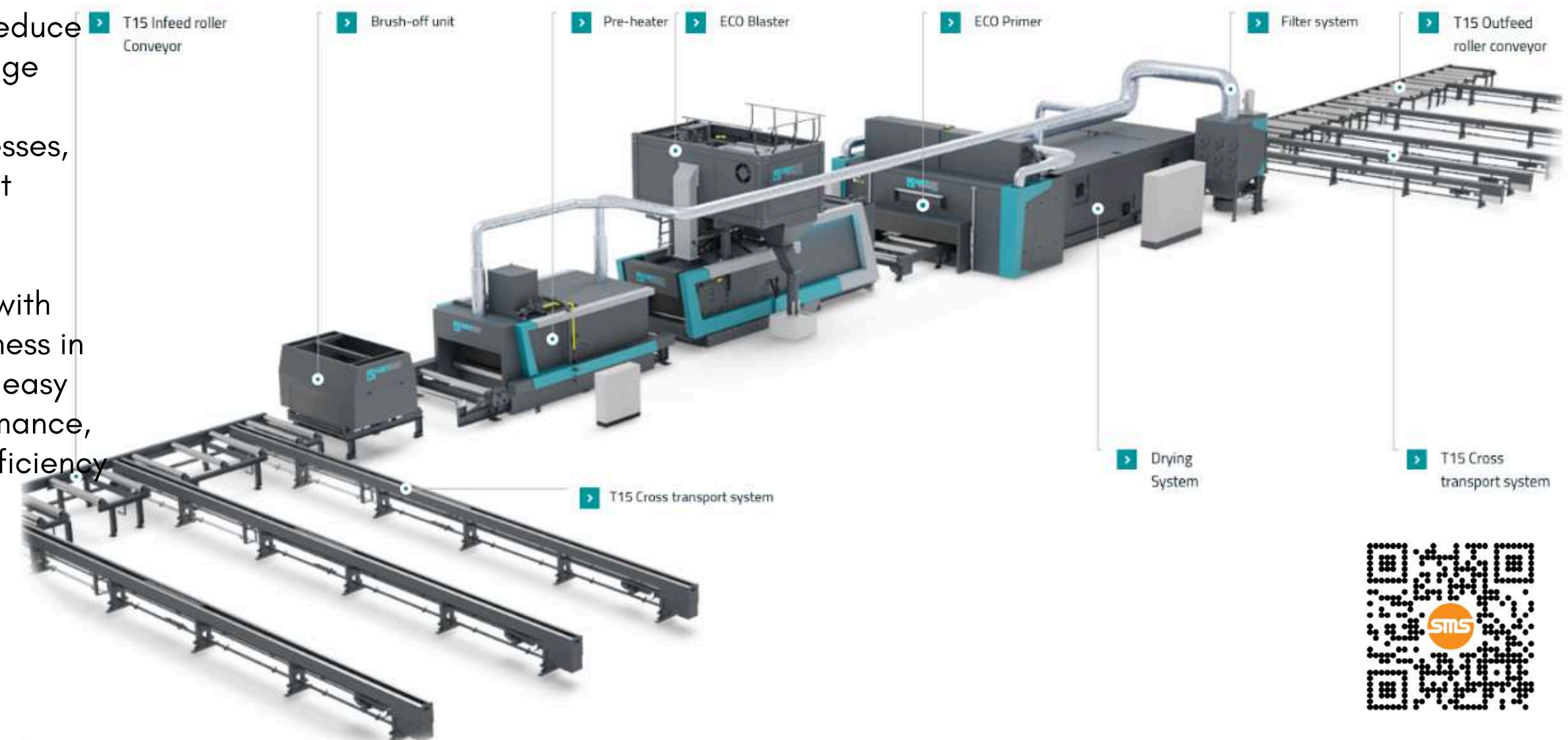

LEARN MORE HERE ►





COMPACT BLASTER WITH SAW DRILL LINE

Discover a powerful and fully reliable system that delivers high-quality and cost-effective surface treatment. This system is the perfect complement to your single Saw Drill and Coping line, providing a comprehensive solution for your production needs.

Experience the benefits of seamless integration and streamlined operations, ensuring efficient and precise surface treatment. With our system, you can achieve superior results while optimising costs, maximising productivity, and maintaining exceptional quality standards.

LEARN MORE HERE ▶

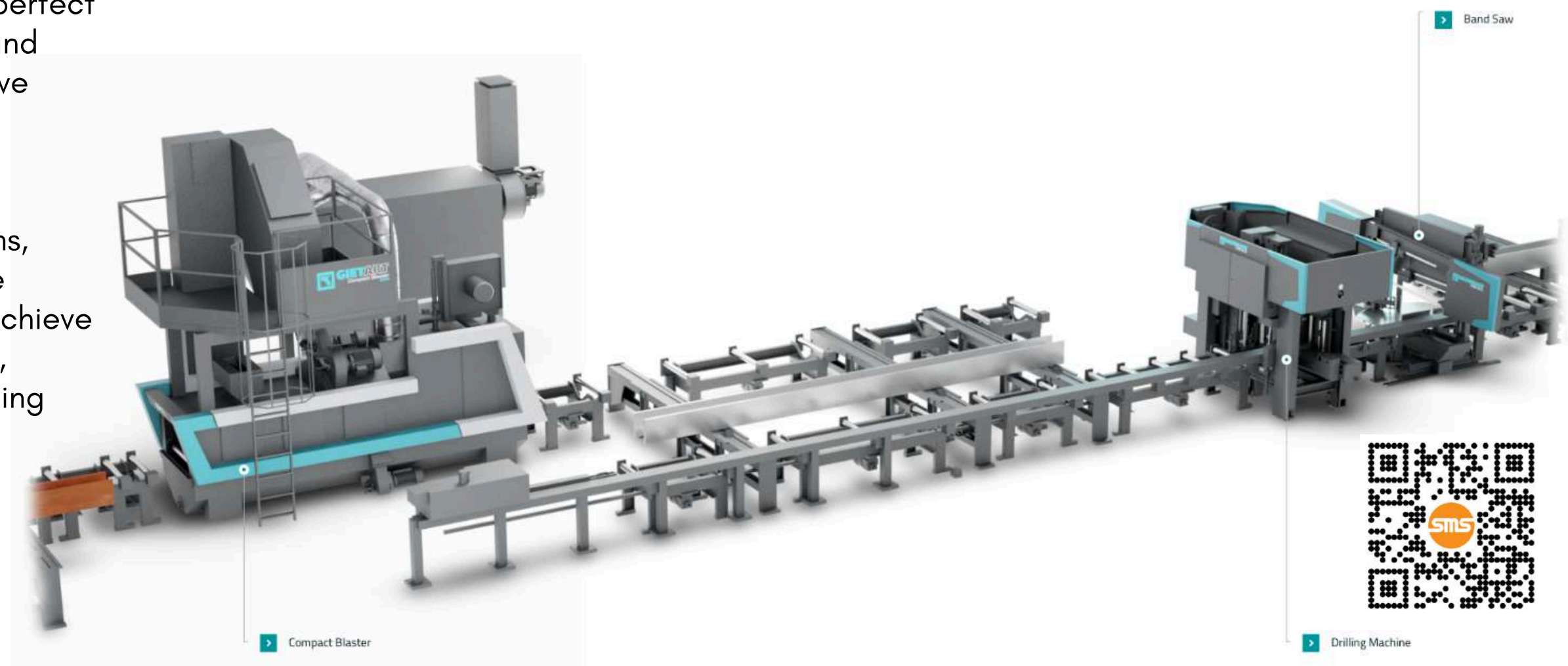



**SPECIALIST
MACHINERY
SALES** AUSTRALIA, NEW ZEALAND & SE ASIA

WHY PARTNER WITH SMS?

Specialist Machinery Sales (SMS) is a complete system and solution provider. SMS proudly offers the complete material handling to meet our client's material flow pain points and challenges; thus, innovating the traditional material flow of a fabricator's workshop- fabrication/assembly and welding out prior to shot blasting and painting.

We are proud to be the only partner in Australia and New Zealand who can provide a complete system and integrate these machines from steel processing for all steel profiles and plate.

We partner with only the best and superior machine tool builders that have been market leaders of innovation and automation to the steel industry. We strongly believe that the future for our clients and the steel industry is to link the various machines and technologies, software, material handling, and automation together.

This is now possible with a mix of new and pre-loved machines that can be integrated into the material handling ecosystem and footprint available when partnering with SMS.





**SPECIALIST
MACHINERY
SALES** AUSTRALIA, NEW ZEALAND & SE ASIA

AUTOMATED SOLUTIONS FOR EACH LEVEL OF REQUIREMENT

Many years of experience and high innovation rates enable us to set the standard in the industry, especially in the areas of sustainability and cost effective processing. As a trend setter and technology leader, we are able to supply premium quality solutions, combined with an attractive and functional machine design.

Our product ranges bring total solutions and special machines for sawing, drilling, plate processing, as well as shot blasting and painting, including logistic and control systems. Powerful, highly versatile systems, whereby quick return on investment is made possible by means of a high level of performance and productivity.

Process optimisation and a wide range of automation possibilities enable an individual adjustment of production and transport processes, according to your requirements. From unique machine software to complete management information systems, SPECIALIST MACHINERY SALES is your specialist machinery partner.



WHO PARTNERED WITH SMS?



Ace Construction Australia



DUNSTEEL



WHO PARTNERED WITH SMS?

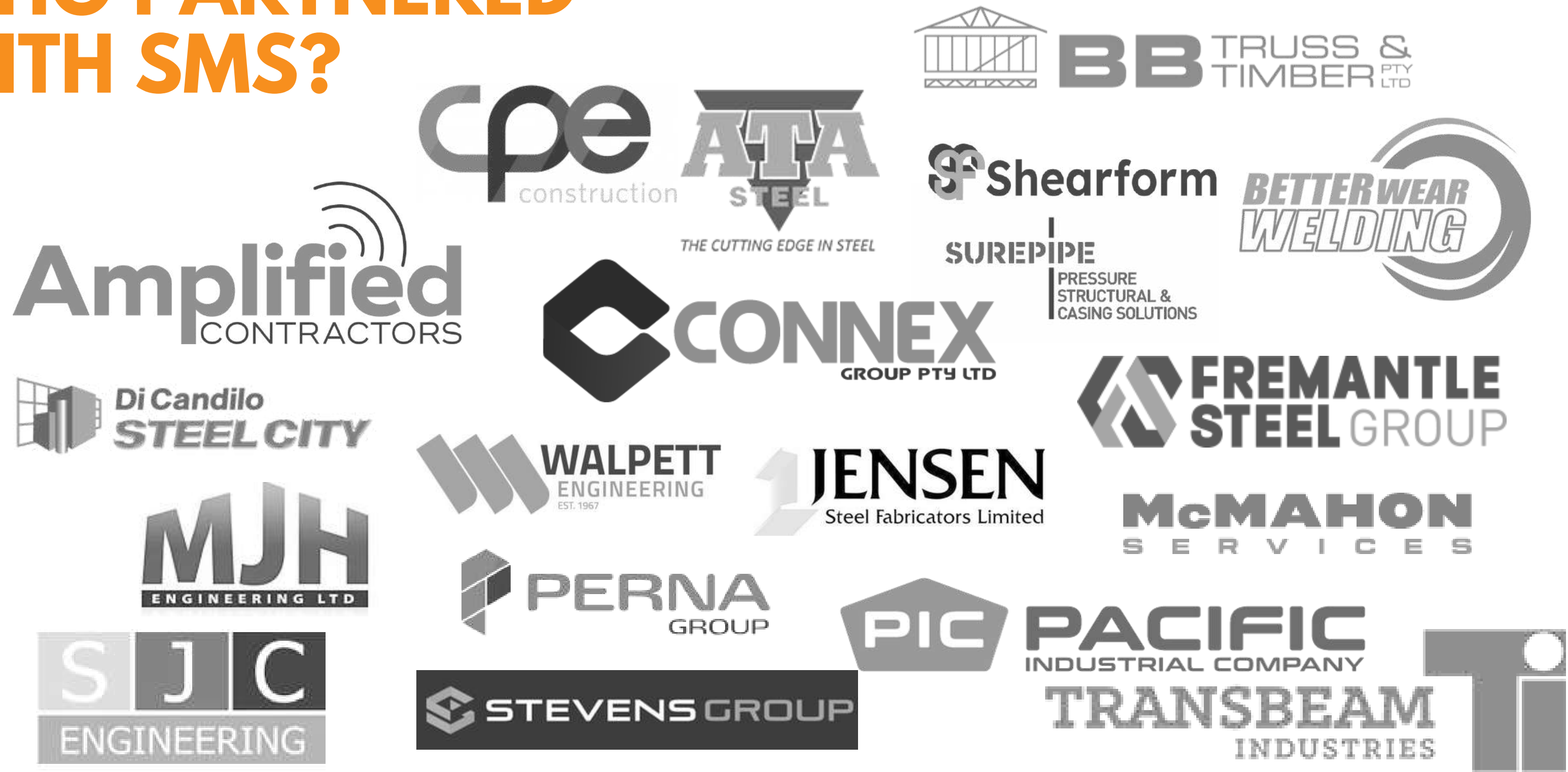



CSF INDUSTRIES INVESTS IN ITS FUTURE WITH SUPERIOR MACHINES EXCLUSIVELY SUPPLIED BY SPECIALIST MACHINERY SALES

A family business established in Cairns in 1979, CSF Industries operates across just about every market imaginable, from mining and defence, through to commercial, industrial and residential.

Their order book regularly encompasses everything from \$3,000 steel supply contracts to \$10 million multi-faceted project delivery.

With such variety, CSF Industries is agile and versatile and has built a reputation for excellence in service and quality. CSF Industries recently worked with SMS to invest in a Superior Structural Steel Automation Beam Assembly and Welding machine plus an add-on-part robotic sorting machine plus a fully-automated beam line working in lights out operation and plate plasma cutting, drilling, stamping, punching, material handling, plate processing machine to ensure that they remain at the forefront of industry.

According to Sean Adams (Director, CSF Industries) "We've invested a lot in technology, processes and procedures throughout the workshop. To do this, we first identified the bottlenecks: sorting parts was one. The add-on-part robotic sorting machine have removed this bottleneck. It performs quality assurance checks and sorts parts unto column and rafter numbers so they are delivered to the fabricator, ready to go."

"The Superior Structural Steel Automation Beam Assembly and Welding machine removes all these issues- it removes downtime from the production process, improving productivity throughout the entire workshop," said Sean.

THE RESULTS

Sean was equally as impressed with CSF Industries' newly purchased Superior Structural Steel Automation Beam Assembly and Welding machine. According to Sean, it has improved on-site rework considerably. "The machine helps us to guarantee the quality of our work. We get a lot of repeat business due to our quality standards and lack of rework."

"Another of the advantages of this superior machine is the consistency of labour that it delivers. We have our machine working on two shifts, for 18 hours a day. In a skills shortage environment, this is really important. We have the confidence that the machine will be there, operating day in, day out. This allows us to commit to jobs we might not have been able to because of the labour component."



PAGE STEEL FABRICATIONS: FUTURE PROOFING VIA AUTOMATION WITH SPECIALIST MACHINERY SALES (SMS)

Page Steel Fabrications was established in Victoria in 1970. Over the last 50 years, the company has expanded significantly, adapting to the rapidly changing nature of the industry with the implementation of advanced software and cutting-edge automation equipment.

Page Steel recently invested over \$3.5 million in robotic fabrication, increasing its capacity by up to 50% and future-proofing the business for the next ten years.

According to Director Chris Piacentini, Page Steel tackles larger projects. "We focus on industrial, commercial and government work—they are our three big sectors. We also target infrastructure work, as well as high-rise residential projects and multi-storey carparks. Our clients are generally tier one, two and three builders."

EMBRACING AUTOMATION

"I really think what differentiates us is how we've embraced and tackled automation," said Chris.

Page Steel has invested heavily in automation, from a high definition plasma machine (that can process plate up to 32mm thick, 3,000mm wide and 12,000mm long), and a CNC oxy cutter (that can process plates over 32mm thick), through to a fully automated CNC angle and plate line, and an automated section blaster with the ability to blast steel at Class 1 to Class 2.5.

AN INVESTMENT IN THE FUTURE

Page Steel recently purchased a Superior Single Rail Robotic Fabrication machine, which is capable of fabricating beams 1,100mm wide and 18,000mm long. The handling robot can pick up 250kg per add-on part and the beam weight has a maximum of 6 tonnes.

"The machinery we've invested in solves a lot of the issues we've been facing in terms of difficulty to recruit workers, accuracy and speed. There are so many pluses to the machine beside the initial investment."



PACIFIC STEEL INCREASED PRODUCTIVITY AND CAPACITY VIA A SUPERIOR STRUCTURAL STEEL AUTOMATION FOR BEAM ASSEMBLY AND WELDING MACHINE

Pacific Steel Constructions is proud of its reputation for providing superior quality steel structures to the building and construction industries. The depth of expertise and vast experience of its four founders enable Pacific Steel to undertake complicated structures and state significant projects.

This expertise has been augmented recently, with their investment in a Superior Structural Steel Automation for Beam Assembly and Welding machine of which Specialist Machinery Sales is the exclusive agent for.

According to Nick Christou (Co-Founder, Pacific Steel Constructions), "This superior machine has opened up the capacity of our workshop. We can now take on multiple projects, all without increasing the size of our workforce or footprint. One of the main reasons we purchased this machine and partnered with SMS was to increase our output and our turnover while maintaining the same size workshop.

We don't have a large workshop, as it has limited floor space, and so we needed to maximise the efficiency of that entire area."

INCREASED QUALITY AND ACCURACY

"Regardless of how stringent your quality system is with conventional fabrication, errors can slip through. Inaccurate steelwork is very costly to repair on-site, causes construction schedule delays, and ultimately damages your reputation," said Christou.

INCREASED PRODUCTIVITY

"Without this superior machine, by the time a boilermaker does the beam marking out, manual handling and tacking, it would require at least 15 minutes per part. For more complex parts that are rotated on three planes, and require extensive setting out, the boilermaker may take up to one hour. Using the machine doesn't matter if the part is straight, or on a complex angle, the entire process takes the same amount of time."

PARTNERING WITH SMS

Todd has supported our workshop's ambition to automate the fabrication and welding of a steel fabrication business when commissioning this superior machine.

I can testify that the SMS partnership is reliable, authentic, passionate and honest when evaluating and supplying technology that future proofs our workshop, so we can win more and do more with less footprint and skilled labour.



DIAB ENGINEERING: PARTNERING WITH SMS

Diab Engineering located in Geraldton in Western Australia specialises in fabrication supplied to the resource recovery sector in WA. The workshop during COVID had sold their fabrication capacity for the next 9 months when metalworking packages were reshored from low labour cost countries that the miners were concerned with supply/schedule issues.

Diab ordered the Superior Structural Steel Automation Beam Assembly and Welding machine due to the COVID travel restrictions at the time did not travel to Europe or Australia to view any installations which isn't the way our business has historically purchased machinery.

This unique buying challenge for a high-value automated fabrication and welding machine meant our businesses needed to rely on the reputation of Todd from SMS plus the technology itself to perform with accuracy.

Diab Engineering obviously needed to rely on the testimonials of existing SMS clients in AU/NZ who were all very satisfied with their buying decision. The existing SMS clients had indicated that Todd was honorable in the way the technology was presented and could be trusted.

The evaluation process for the technology that Todd guided us through was robust so our team could identify where this superior machine would positively impact our workshops capacity to deliver fabricated steel accurately to tight schedules.

The machine delivery ran on time and the commissioning, training and after-sales service/support have been what was promised.

Diab can trust the technology that was provided to be accurate, efficient, safe and profitable for the businesses overall success.



DUNSTEEL INVESTS IN KALTENBACH SYSTEM

For more than 50 years has been, Dunsteel remains a proudly family-owned and operated business. Dunsteel specialises in complex projects for leading building firms and architects and is at the forefront of prefabricated stairway design for large multi-storey buildings.

According to Dunsteel's Director, Jonathon Dunlop, they invested in the Kaltenbach steel processing system, to help improve productivity and bolster efficiency.

INCREASED PRODUCTION

"Our ambition is to have the machine working two shifts per day—to load it up and then leave it alone. Depending on the complexity of the job, this outcome is achievable and does happen."

LAYOUT MARKING

By automating layout marking, the fabrication schedule can be improved by as much as 30 per cent, without increasing headcount or footprint. It also improves accuracy on-site, helping to eradicate rework.

EXTRA SERVICE

A couple of the extra features that Kaltenbach offered were the additional X-axis on the drilling line, allowing for multiple operations to be conducted at once, and a function called AFC (Automatic Feed Control) on the saw line that enables a pivoting action on the band saw," said Dunlop.

CUSTOMER SERVICE TO COUNT ON

"We chose to partner with Kaltenbach because we felt that their culture was a good fit with our 'family business' style of operating. Kaltenbach felt like a small, tightly managed organisation, as opposed to some of the other players in the market that are much bigger," said Dunlop.



HOW AUTOMATION DOUBLED ACA'S CAPACITY

Based in Ingleburn, New South Wales, Ace Construction Australia (ACA) specialises in architectural, structural general fabrication and installation.

Since the company's inception 15 years ago, ACA has earned a solid reputation for high-quality workmanship and expanded rapidly as a result.

To augment this expansion, ACA recently became the first company in New South Wales to invest in a Superior Coping Robot 3D Profile Plasma Cutting Machine, exclusively supplied by Specialist Machinery Sales.

This investment has doubled ACA's fabrication capacity, without increasing their footprint or headcount and helped to future proof the business profit from avoiding rework. According to Mohamed Elomar (General Manager, ACA), when he first established the company, the only automated machinery in the workshop was a saw, punch and shearing machine.

"We decided that to keep pace with the industry, we needed to invest in automation. So, we purchased a CNC machine. While this helped to augment our operations, we really wanted to move to a machine that could do it all—plasma cutting holes, on all profiles including SHS and RHS, complex coping and add-on-part layout marking without requiring re-work by the boilermaker."

THE RESULTS

ACA has doubled the capacity of their workshop. "Prior to the installation of the machine supplied by SMS, we produced 50 tonnes per week. Now we can produce 100 tonnes per week—all without increasing either our workforce or our footprint." This increased capacity means that ACA can meet clients' project timeframes much more easily, and is even able to sell their excess capacity to some of the local steel service centres.

"When tendering, I know I have a higher chance of winning projects now—everyone else is relying on traditional fabrication methods or traditional coping robots that require considerable rework for every profile. Our natural competitors cannot supply the same capacity, schedule, quality and man-hours per tonne. Partnering with SMS means that I win more work and increase my profits," said Elomar.



CIVMEC: PRODUCTION CAPACITY BROUGHT TO THE NEXT LEVEL WITH FOUR SMS SUPERIOR MACHINES

CIVMEC is an integrated multi-disciplinary heavy engineering and construction provider located in Henderson, Western Australia. They provide services to metals and minerals, oil and gas, infrastructure, water and energy, as well as marine and defence markets.

Fundamental to their strategy is their diverse range of capabilities that enables them to provide a large scale of complementary in-house core competencies and services including heavy engineering, modularisation, structural mechanical, piping and electrical.

CIVMEC is very on-point when it comes to innovation to improve the company's productivity and efficiency. That is why they have chosen to partner with Specialist Machinery Sales and invest in their superior machinery. "Originally a part of the reason why we bought the Superior 3D Profile Plasma Cutting and Coping Robot was that we wanted to be able to bevel box sections, which we weren't able to do previously".

"The Superior Cope Robot is a very good machine. We have utilised it at the end of our beamlines, so we got an automatic beamline. It gives us the ability to double-bevel the flanges on the beams, which previously we were not able to do."

The company was very pleased with its result and invested in three more machines in the span of 24 months. Now the company is a proud owner of 4 SMS superior machines - two Superior Pipe Cutting Machines, one Superior Robot Profile Cutting Line and the latest addition - one Superior Cope Robot which automates their cutting work.

"The fit-up is significantly less because we don't have to manually bevel plates, pipes or the beams. It is the correct coming off the machine. It reduces the number of man-hours associated with fit-ups for sure." David said.



SOUTHERN QUEENSLAND STEEL (SQS): "THERE'S NOT A PROFILE WE CAN'T CUT!"

Southern Queensland Steel (SQS) is a family-owned steel processing company from Queensland, Australia. Investing in the SMS RPC1200 beam cutting machine brought the company a competitive advantage: "There isn't a cut we can't make".

Due to the need for innovation, Southern Queensland Steel decided to expand their machinery with Superior Beam Cutting machine, exclusively supplied by Specialist Machinery Sales.

SQS is proud of the most recent innovation they brought to their facility. It is not only the high cut quality when cutting haunches, tapers or bevel, which makes SQS proud of its brand-new coping robot, but even more when it comes to the specials.

"We have a competitive advantage in the market", according to Teunissen. "There isn't a profile we can't process and produce a finished product on the first attempt".

THE RESULTS

Even the most complex of work that SQS throws at the SMS is produced with high quality and excellent accuracy.

Also cutting RHS around the corner and cutting flanges away to the web is being done with utmost accuracy on the Superior coping robot. This beam cutting machine helped Southern Queensland Steel to add even more value to their customers' steel.

The Superior Beam Cutting machine helped Southern Queensland Steel to add even more value to their customers' steel. "It helped us grow the business in the fact that we can now do everything", Thornton says. "The customer doesn't have the need to go anywhere else".



LOOKING TO BUY PRE-LOVED MACHINERY?

Specialist Machinery Sales offer second-hand or used structural steel processing machinery from Kaltenbach, Gietart, Haeusler, SLF and more.

Generally, the machines that SMS has access to are from trading for new machines offered from the machine tool builders to clients of SMS in Australia and New Zealand. Most machines are between 5 and 15 years of age with full-service history available. Some machines can be inspected under power or in their shipping packing ready for immediate delivery to Australasia.



[LEARN MORE HERE ▶](#)





READY TO SELL YOUR PRE-LOVED MACHINERY?

Selling your pre-loved machinery may appear to be a simple process but it might be more complicated than you think. Selling pre-loved machinery involves equipment liens, resale certificates and financing a buyer. BUT DO NOT WORRY!

Used Structural Machinery (USM) is here to partner with you. At USM, we are your ideal channel to take your equipment and place it in the right hands, with the security and confidence that characterises us. Review our checklist below to help you understand when to retire your machine and how USM can help you sell it off efficiently and effectively.

[LEARN MORE HERE ▶](#)



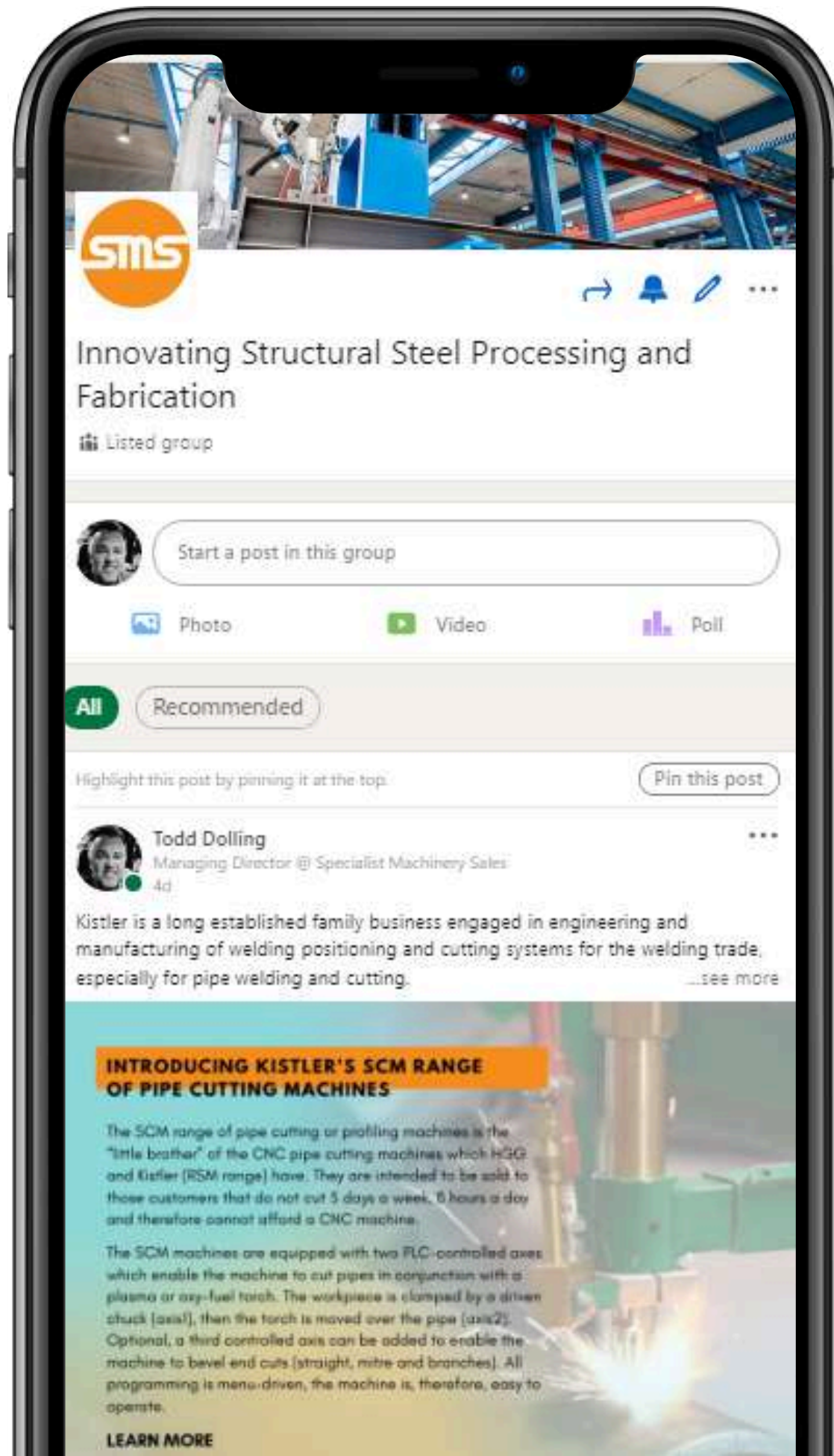

JOIN OUR EXCLUSIVE AND GROWING LINKEDIN GROUP

Join our growing and exclusive LinkedIn Group - [Innovating Structural Steel Processing and Fabrication Group](#).

In this group, we bring in thought leadership content, topics, trends and challenges within the steel industry and steel processing automation. We encourage everyone to share your business challenges and solutions that you have encountered and how steel processing automation had helped achieved your business objectives.

JOIN HERE ►



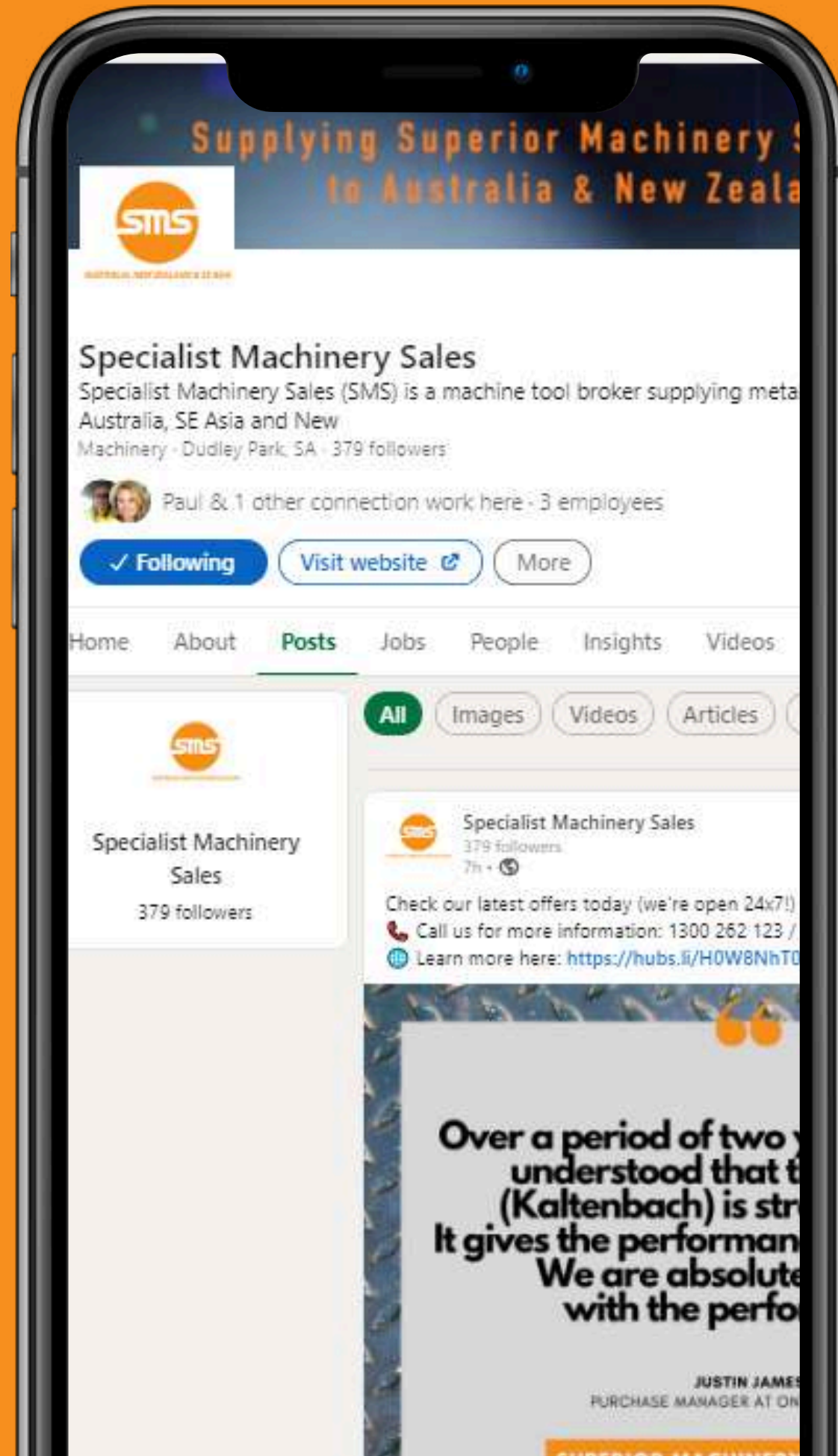

HATE MISSING OUT?

Be the first to receive the latest promotions, new releases and discounted offers by following us on social:





**SPECIALIST
MACHINERY
SALES**

AUSTRALIA, NEW ZEALAND & SE ASIA



1300 262 123 / +61 8 6500 6880



**tellmemore@smsales.com.au
www.SMSales.com.au**

