



**SPECIALIST
MACHINERY
SALES**

AUSTRALIA, NEW ZEALAND & SE ASIA

THOUGHT-LEADER IN STEEL PROCESSING AUTOMATION

SUPERIOR MACHINERY SYSTEMS

LASER HARDENING HARDNESS AND PRECISION



1300 262 123 / +61 8 6500 6880



**tellmemore@smsales.com.au
www.SMSales.com.au**



WHAT'S INSIDE:

- [\[VIDEO\] LASER CLADDING INTRODUCTION AND EXAMPLES](#)
- [LASER CUTTING WITH DIODE LASERS](#)
- [LASER CLADDING BY POWDER VIDEOS](#)
- [LASER WELDING VIDEOS](#)
- [LASER HARDENING VIDEOS](#)
- [\[VIDEOS\] DIODE LASER EXPLANATION AND TEST PIECE DEMO](#)
- [THE GERMAN-MANUFACTURED LASERLINE DIODE LASER](#)
- [DIFFERENCES BETWEEN FIBRE AND DIODE LASERS](#)
- [LASERLINE CLADDING AND ADDITIVE MANUFACTURING](#)
- [THE BENCHMARK FOR DIODE LASERS - LASERLINE LDF](#)
- [PROCESSING OPTICS](#)
- [HOW CAN LASERLINE SYSTEMS HELP YOU INNOVATE?](#)
- [PROCESSING HEADS - ALOHARD](#)
- [SUPPORT AND CONSULT](#)
- [YOUR MACHINERY OPTIONS](#)
- [OUR INDUSTRY SOLUTIONS](#)
- [WHY PARTNER WITH SMS](#)
- [WHO PARTNERED WITH SMS](#)
- [CLIENT SUCCESS STORIES](#)





LASER CLADDING INTRODUCTION AND EXAMPLES

Buckle up for a high-octane exploration of Laser Metal Deposition (LMD), also commonly referred to as laser cladding, as we navigate through its multifaceted applications.

In this informative session, we'll be unearthing the power of LMD across the four pivotal industrial domains of corrosion protection, wear-resistant coatings, precision repair welding, and cutting-edge additive manufacturing.

Join us for an in-depth analysis, led by Markus Rütering, Sales Director at Laserline, where we'll dissect the nuanced intricacies of LMD, uncover its unparalleled precision, and ignite discussions on its integration into the industrial machinery landscape.





LASER CUTTING WITH DIODE LASERS

Compared to other applications, laser cutting makes the highest demands on the laser beam's focus-ability. For a couple of years now, the diode lasers of Laserline have more than met the necessary requirements and are used in robot-based cutting applications in production.

The advantages of laser cutting compared to other methods - contact-free, force-free, low heat input, high cutting speed, absence of burr - will only reach their full potential when using diode lasers.

The biggest advantages of the diode laser only come into play when the same beam source is simultaneously used not only for cutting, but also for other methods like welding and brazing in car body construction. Here, other laser beam sources are inferior to the diode laser as a universal tool.





LASER WELDING VIDEOS



LASER WELDING VERSUS LASER BRAZING



LASER WELDING WITH SPOT-IN-SPOT DESIGN



LASER WELDING VIDEOS

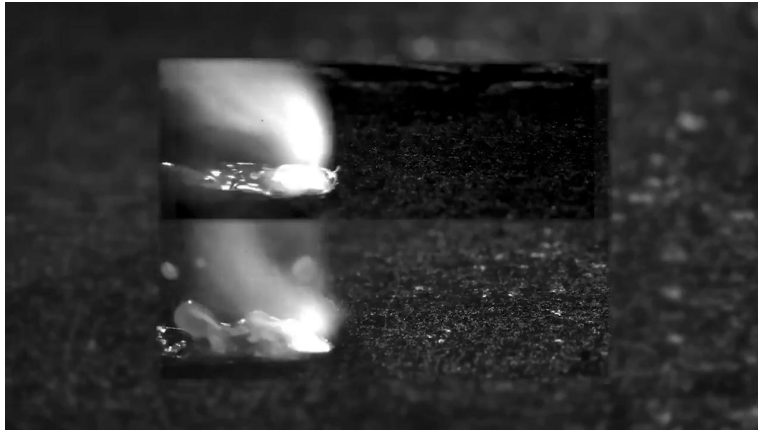

LASER WELDING - SMOOTH PROCESS WITH SPOT IN SPOT



LASER WELDING WITH MULTI-SPOT MODULE AND COLD WIRE



LASER HARDENING VIDEOS

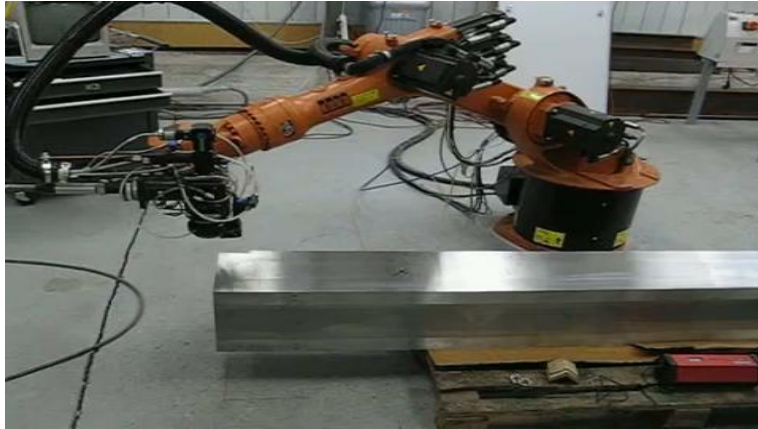

LASER HARDENING WITH DIODE LASERS



LASER HARDENING WITH VARIABLE RECTANGULAR SPOTS



LASER HARDENING VIDEOS

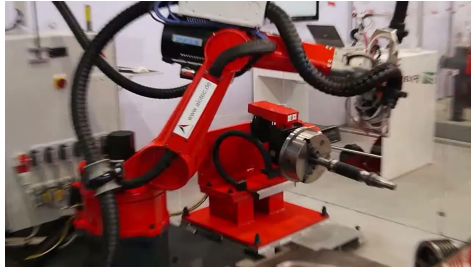

LASER HARDENING OF TRANSMISSION COMPONENTS

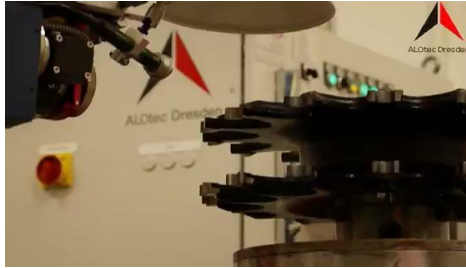

LASER HARDENING OF A SPROCKET



LASER HARDENING OF A SHAFT



LASER HARDENING OF A GEAR



LASER HARDENING OF A GEAR -
7 ROBOT AXES SIMULTANEOUSLY



LASER HARDENING OF A FORMING TOOL



LASER HARDENING VIDEOS



LASER HARDENING OF A CUTTING KNIFE



LASER HARDENING WITH ALOHARDSCAN
ALONG A CURVED PATH



LASER HARDENING OF A RACK

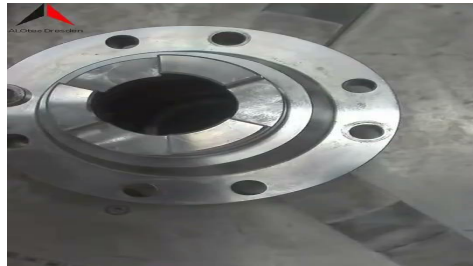

LASER HARDENING OF A COUPLING PIECE



LASER HARDENING OF A BEVEL GEAR



LASER HARDENING ALONG A 3D FREEFORM
SURFACE WITH ALOHARDSCAN



**SPECIALIST
MACHINERY
SALES** AUSTRALIA, NEW ZEALAND & SE ASIA

DIODE LASER HEAD AND TEST PIECE EXPLAINED

INFORMAL GOPRO VIDEOS TAKEN BY TODD DOLLING, SPECIALIST MACHINERY SALES BUSINESS OWNER, WHEN HE VISITED THIS COMPANY IN GERMANY SEPTEMBER 2023

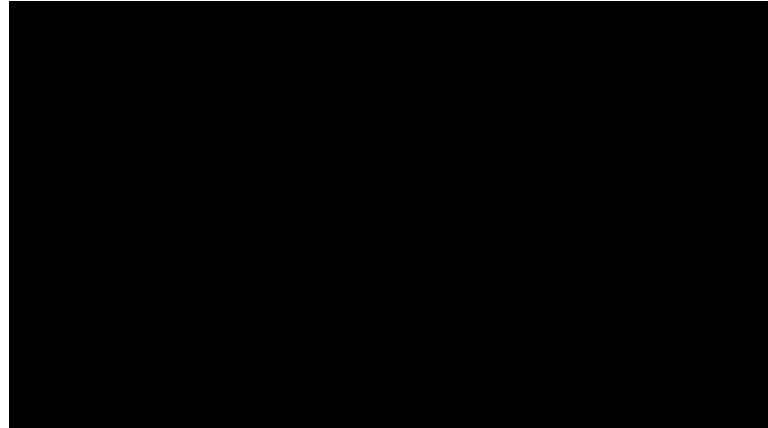



DIODE LASER EXAMPLES

INFORMAL GOPRO VIDEOS TAKEN BY TODD DOLLING, SPECIALIST MACHINERY SALES BUSINESS OWNER, WHEN HE VISITED THIS COMPANY IN GERMANY SEPTEMBER 2023





THE GERMAN-MANUFACTURED LASERLINE DIODE LASER - THE HEART OF BEAM GENERATION

The laser beam source includes several diode laser stacks, consisting of single diode bars. The number of bars per stack and the total number of stacks determine the output laser power and the required beam quality. With the help of simple, patented technology, the beams of the individual diodes are overlaid into one common laser beam and coupled into a fiber-optic cable. **In most cases, the modular design of the laser head makes it possible to further equip the systems with more stacks so as to increase its power subsequently. This allows a worksop to start with a smaller laser kW and scale up to larger kW and up to 6 torches cutting/cladding heads in one laser system.**

High-power Diode Lasers

Diode lasers are typical semiconductor lasers where the laser is generated in a p-n junction diode. To generate multi kilowatt power the several laser diodes are stacked together to form diode laser bars. The conversion efficiency of diode lasers can go up to 52% in several cases.

Combined with 900-1100 nm wavelength, high power, stability and homogeneous beam diode lasers are used mainly for laser welding, laser cladding and laser hardening applications. **These lasers are very robust and have a long life time and are most suited for heavy production in industrial environments. For many applications like cladding, hardening, brazing, plastic and metal welding diode lasers are more suitable than fiber and CO2 lasers.**

Diode Lasers - Getting light from electricity directly

Laserline's high-powered lasers are characterised by the direct use of diodes as the most efficient form of beam generation. The basic advantage of high-power diode lasers lies in the direct transformation of electricity into light without the indirect route of passing via a pump medium. **This means that diode lasers are more compact, more efficient, more mobile and easier to handle than all the other lasers.** Diode lasers are a winning option: they are almost maintenance-free and have long lifetimes.

High-power lasers that are verging on zero-maintenance

Reliability and process efficiency are key requirements for tools used in industrial production. **Fail-safe continuous operation in a multiple-shift operation, including in difficult ambient conditions, is, therefore, the benchmark for our products in terms of quality.**

The highest possible process stability and system availability in a triple-shift operation are the requirements in the automobile industry, as fulfilled and proven by the diode lasers in a host of applications for years now. **With an almost zero-maintenance operation and a lifetime of much more than 30,000 operating hours at its highest efficiency, the direct diode laser is clearly superior to other laser beam sources.** As a comparison: with lamp-pumped Nd:YAG lasers, the lamps need to be changed about every 1,000 operation hours, which always entails downtime and service costs.

DIFFERENCES BETWEEN FIBRE AND DIODE LASERS

GAUSSIAN

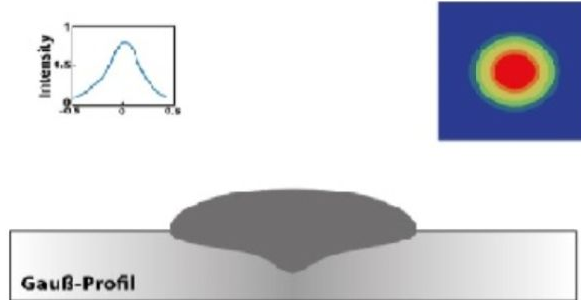

- Typical for highly brilliant lasers like fibre or disc laser
- Overheats the base material in the centre of the laser beam
- High dilution form base material into clad layer

TOP HAT

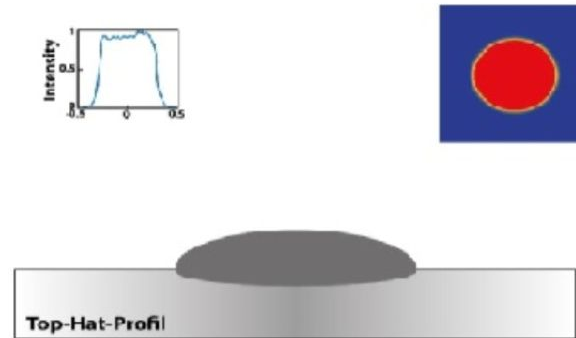

- Typical for diode lasers
- Prevents overheating of the disc material
- Low melt pool / dilution / heat affected zone



LASERLINE CLADDING AND ADDITIVE MANUFACTURING

Cladding is the most efficient way to carry out deposition welding. With only one single laser beam source, all wire and power layers can be applied onto a surface regardless of whether it is heavy industry, automotive or agriculture – anti-corrosion coating, wear protection, repair or a new component.



Laserline's diode lasers
for metal, fibrous composite
material and additive
manufacturing

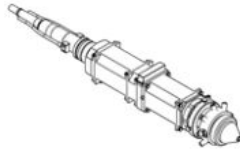

Laserline's optics
for industrial material
processing with diode
lasers

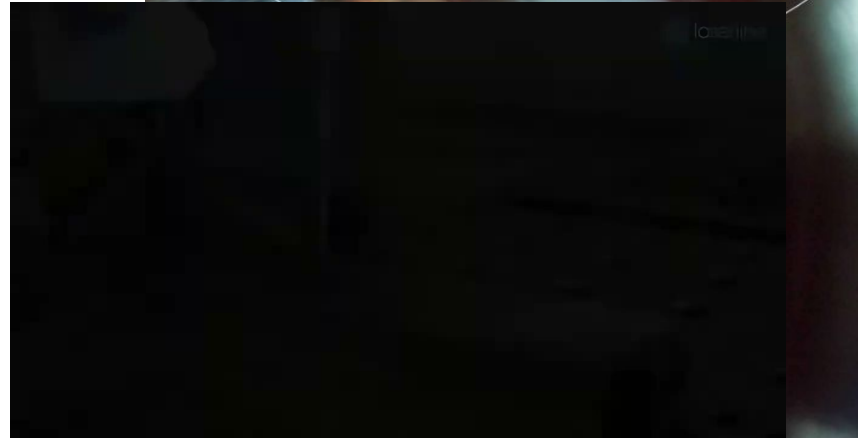



LASER CLADDING AND HIGH SPEED CLADDING

Laserline Senior Sales Manager in Germany explaining the latest Laser Cladding and Welding Applications with the Diode Laserline System Manufactured in Germany

In this presentation, Senior Sales Manager Dr. Andre Eltze delves into the fascinating world of laser cladding, providing insightful examples from its primary application areas.

One area of particular focus is high-speed cladding, known as EHLA (Extreme High-Speed Laser Material Deposition), and its specific application in enhancing brake discs.

Dr. Eltze will explore the intricacies and benefits of laser cladding, shedding light on its numerous applications and the transformative impact it has on industries such as automotive manufacturing.

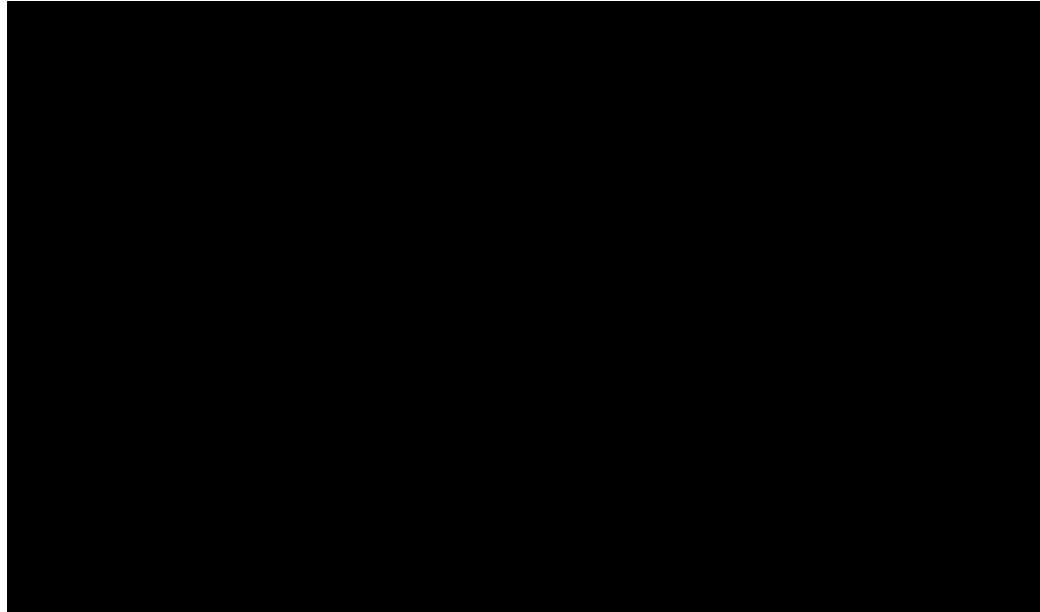



THE BRAKE FOR LESS FINE DUST NEW EURO 7 POLLUTION RULES

The friction between brake discs and linings generates fine dust, a significant contributor to the overall fine dust load.

Thanks to cutting-edge laser cladding technologies, we can now produce low-wear brake discs that drastically minimise fine dust emissions.

By adding a layer of materials like tungsten carbide to the base, we achieve exceptional abrasion resistance, ushering in an era of economically efficient and environmentally friendly brake disc manufacturing.

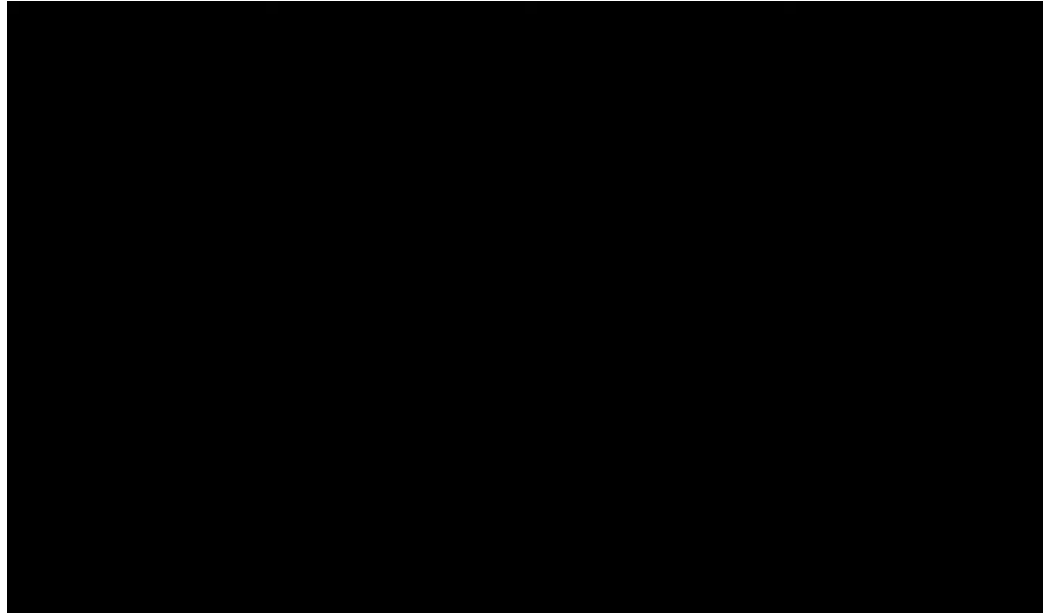



HOW TO PROTECT INVESTMENTS IN A SMART WAY

Cladding has been established in many branches as a technological benchmark. With continuous technological innovation and a wide application spectrum, Laserline's cladding solutions are currently being used on many fields, increasingly displace classical methods, and conquer new application fields.

"As an Institute in the Fraunhofer Society, we always follow the target to develop innovative solutions for industrial processes that allow the user to take a definitive and great leap forward. Here, we have appreciated the extremely constructive and successful collaboration with Laserline." -Prof. Dr.-Ing. Christoph Leyens, Head of Fraunhofer Institute for Material and Beam IWS Dresden and Director of Institute of Material Science, Technical University Dresden





UPCYCLING IN A BIG WAY

Cracks, tears, removals and damaged coatings can become expensive. A repair with laser deposition welding has the advantage of ensuring that precious components need not be completely replaced: they continue to work anyway.

During repair welding, wire or powder is metallurgically joined with the basic material. Because of this, following the ablation of the coating and cleansing of the workpiece, extremely stable new coatings are created, e.g. at rollers, gear wheels, drive shafts, molds, tools and bearings.

To repair worn surfaces, torn-off pieces or other damages, identical materials are for the most part applied to the base material, e.g. stainless steel, nickel and cobalt base alloys or aluminum. Basically, every weldable raw material is possible.

“GTV as a leading manufacturer turnkey coating centres has to rely on robust and reliable laser. Diode lasers from Laserline offer us the ideal tool, in order to reliably withstand even the most demanding production tasks.” - Dr.-Ing. Konstantin von Niessen, Managing Director of GTV Verschleißschutz GmbH



TURBINE REPAIRS AT SIEMENS IN NUREMBERG / GERMANY

BATTLE AGAINST CORROSION

Industrial components have to be protected specifically well from corrosion. Coatings with diode lasers by Laserline make sure that the expensive workpieces can do their job reliably over long periods.

Whether with ambient air, water, chemicals or pollution: every raw material reacts to its surrounding area. Corrosion is the inevitable consequence. Laser coatings protect from this. With high-precisely applied additional layers, creep corrosion and crevice corrosion can be prevented.

For this, stainless steels and nickel-base alloys are applied to low-alloy steels. When using a Laserline diode laser as energy source, the dilution of base and clad material is usually below 5%. Thus, a workpiece can be well protected even with a single layer of about 1 mm thickness (classical methods usually need two layers).

Diode lasers for coating are used for corrosion protection in the most diverse areas: In mining, on the high seas, in power plants and wherever coatings corrode quickly under the local atmosphere.

The surface coating via diode lasers doubles the corrosion protection of components in demanding environments, in addition to being clearly thinner compared to conventional methods.



Here a 10 kW laser for cladding of mine cylinders in a machine of Anyang Rui Heng CNC Machine Tool Co., Ltd., Anyang City / China.



3-D PERSPECTIVES

3-D print has become more and more established in industrial fields. Additive manufacturing with Laserline's diode lasers allows for a totally new production method, which enables to manufacture components up to ten times quicker compared to the powder bed method.

Additive Manufacturing with Laserline diode lasers offers innovative production opportunities in many fields. With this method, layers from identical materials are applied with great efficiency, e.g. stainless steel, aluminum, titanium or even superalloys for aircraft construction. Thus, even complex manufacturing processes can be realised based on a single beam source.

The possibilities are far more than additive powder supply and subtractive chipping: Lasers can also be used for welding and hardening in a twelve-axis milling machine, or for 3D-structure at prototypes and in mass production. A promising approach is the integration of the beam source into machines tools, e.g. when uniting a laser with a 5-axis milling machine.

Laserline optics are very well suited for additive manufacturing.



Complex geometry possibilities with diode lasers in additive manufacturing.





STAYS LONGER, PROTECTS BETTER

With laser cladding, not only is a new material applied to an existing underground, but even more, a metallurgical connection is created between the basic material and additional layer: Up to 300% longer lifetimes are possible!

Laser cladding brings about an excellent wear protection. Other methods cannot keep up with this. Because of the metallurgical connection between the base material and additional layer, clearly longer lifetimes can be attained compared to the purely mechanical connection at thermal spraying: An increase of up to 300% and even more is not uncommon. The cost benefits are obvious.

Mostly, at laser deposition welding nickel base alloys with tungsten carbides are used – usually they make up to 60% of the applied layer's weight. With diode lasers, layers reinforced by carbides can be realised optimally on e.g. iron based materials. Among others, they protect the saw-blades, disc harrows or counter blades from wear and corrosion.

Laser-coated brake discs, for example, lead to a clear decrease in fine dust emissions and protect them better from corrosion. In this, within a high-speed process, a metallic melt splice between powder and base material is created that is only slightly loaded thermally. This is also ideal for industrial mass production such as for electric vehicles of the future. ***The lifetimes are up to 300% longer due to the metallurgical surface refinement via diode lasers.***



Wear protection of saw-blades, disc harrows or counter blades in agriculture and forestry.

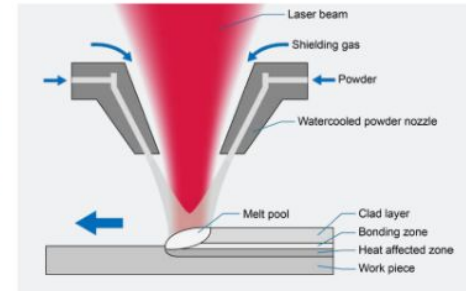

The laser beam creates a molten pool on the workpiece surface, to which the coating material (powder) is added and fused by the laser simultaneously.



HIGH SPEED, HIGH VOLUME

The high-speed laser deposition welding (EHLA by Fraunhofer ILT) offers an economical alternative to hard chromium plating, which is hazardous to health. Laserline's diode lasers are ideally suitable for the new method – an important step into a clean future.

High speed cladding

Hard chromium plating with chrome (VI) has been banned in the EU since 2017. Thus, the Fraunhofer Institute for Laser Technology (ILT) has developed a new technique that allows for a high processing speed at low layer thicknesses and can cope with little laser power: It is called extreme high-speed laser deposition welding (EHLA), also known as High Speed Cladding. Laserline's diode lasers are perfectly suited for this.

Because of special adjustment to the laser beam and powder nozzles, the layer material is fused before it meets the workpiece. The process speed is accelerated up to a factor of 10 and at the same time save energy and powder. Even extremely thin layers of about 10 µm are easily feasible.

10x accelerated process speed through optimal adjustment



High Speed Cladding on a hydraulic cylinder, ACunity GmbH, Aachen / Germany.



HIGH SPEED, HIGH VOLUME

High volume cladding

For coating of large components or for wear protection of cylinders, already today multi-kW systems between 11 and 20 kW are used, Volume rates of up to 14 kg/h paired with powder efficiencies in the range around 90% are realised.

In the future, lasers with 50 kW output power become more important in industrial use: 35 kg/h order rate at 3.5 m²/h at 50 kW -this record outnumbers the state of the art by a factor of 2-3 and are already tested on a laboratory scale.





IT DEPENDS ON THE NOZZLE

Which optics with which powder nozzle is most suitable for which filler material and for which application? We are pleased to help you with the configuration! Because with coating and additive manufacturing, the nozzle also plays a key role in the success of the process.

The powder nozzle decisively determines the efficiency and quality when it comes to coating and 3-D prints. Besides the supply of the filler material in powder or wire form, the processing location is shielded by protective gas from oxygen in the ambient air.

Spot size, material selection and accessibility of the processing location are only some of the important selection criteria. Depending on the concrete application and individual demands, the correct processing nozzle should be selected. Our experts will advise and support you all the way until you find the right configuration for your project.

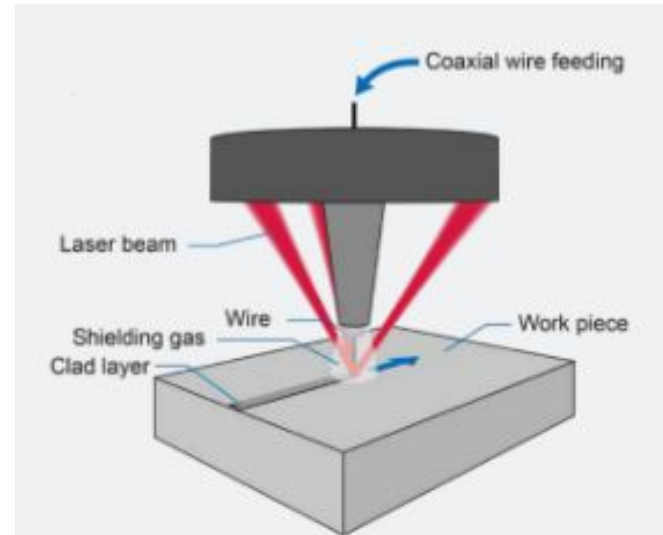

The laser beam creates a molten pool on the workpiece surface, to which the coating material (wire) is added and fused by the laser simultaneously.



IT DEPENDS ON THE NOZZLE



Optics with off-axis nozzle

Robust, simple and cost-effective alternative to broad beam nozzles for coating of shafts for the protection of hydraulic cylinders from corrosion.



Optics with a variable spot size

No modification, no set-up: A variable spot size allows fligree contours and large-scale coatings with one processing head.



**SPECIALIST
MACHINERY
SALES** AUSTRALIA, NEW ZEALAND & SE ASIA

TO THE POINT

Tailored solutions constitute an essential part of the Laserline philosophy. In our application laboratories we define the optimal set-up of laser and optics for every specific demand - to ensure that your cladding solution will be a success.

At Laserline's headquarter in Mülheim-Kärlich as well as in China, Japan, Korea, India and in the USA, we have built first-class and fully-equipped application laboratories. Here, a team of experienced application engineers will take care of the first feasibility studies and advise you in terms of plant design and selection of suitable beam sources.

Our worldwide expert network comprising competent system integrators and representatives of renowned research institutes is available at all times. When a sustainable concept is set up, a prototype can be created and tested under production-like conditions. The models for mass production will not be finalised until it is absolutely certain that the system will operate as planned.

In close coordination with you, we develop step by step a cladding solution that exactly meets the concrete demands of your application. The modular design of our diode lasers has proven itself time and again to constitute a major advantage: subcomponents can be combined in different ways, while special spots or special optics pose no problem whatsoever.

***"We make cladding the new productive factor of your company." -Dr. Sörn Ocylok,
Customer Support Cladding & Additive Manufacturing, Laserline***

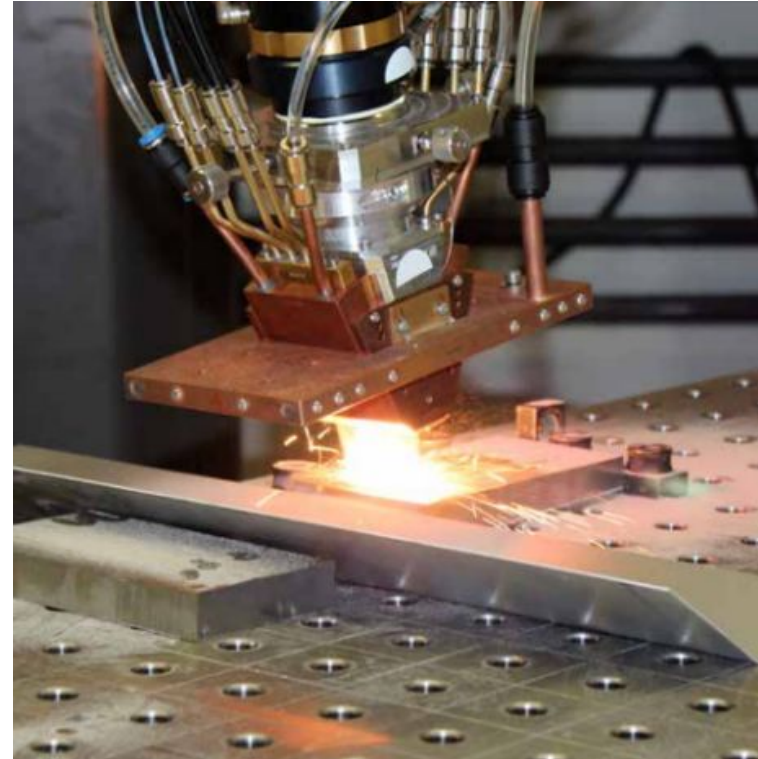



THE BENCHMARK FOR DIODE LASERS - LASERLINE LDF

The Modular Laserline - LDF Platform

How can superior technology be improved? By making it more versatile to use while preserving all proven properties.

The Laserline LDF diode laser of the 6th generation sets the standards for industrial applications in the multi-kilowatts range with regard to power, mobility, efficiency and easier maintenance.





45 KW LASER POWER IN LESS THAN TWO SQUARE METER FOOTPRINT

The LDF platform - Thinking into the future

With the LDF series Laserline is setting the benchmarks for high power diode lasers. Even devices with over 20 kW laser power are set on sturdy castors allowing a single employee to move the laser to different locations for start-up in production – a unique benefit. All you need is electricity, water and an optical fiber – and the laser is ready for use at its new site.

Thanks to permanent development of our proven active diode cooling technology the system family is optimised to multi-kilowatt power levels even at high beam qualities: 8 kW out of a 600 µm fiber at NA 0.1 in a compact system configuration at less than one square meter footprint.



Mobile control unit, freely positionable



Innovative access to interfaces



45 KW LASER POWER IN LESS THAN TWO SQUARE METER FOOTPRINT

A modular concept provides maximum flexibility

Whether power, cooling or system interfaces: The LDF series can be individually configured and adapted to changing requirements. The systems are available with internal or external cooling system as water/water or water/air version.

With these Laserline chillers, perfectly aligned to the product line and fully integrated in the control system, high power lasers can now be operated permanently in production with a low footprint requirement. Through the internal networking of all system components malfunctions can be diagnosed in real-time and resolved immediately.

The benchmark for performance and functionality

With an electrical efficiency of up to 50 percent, LDF diode lasers have the highest efficiency of all beam sources. The functionality leaves nothing to be desired: Thanks to the mobile hot-pluggable control panel the LDF lasers can be monitored and controlled very flexibly from a distance.

The three-stage fault management system displays information, warning and error messages, identifies causes and guides the user directly to efficient troubleshooting where appropriate. Service areas and interfaces are easily accessible through a retractable hood. System components can be easily replaced, avoiding any slowdown to the production process.

The intelligent system control makes the difference

An industrial, latest-generation Ethernet network combines the system components and interfaces with the central control unit, which monitors the entire process in real time. An OPC UA interface creates the prerequisites for platform-independent, vertical and horizontal data communication. It enables the integration of lasers in modern system architectures. All information is available at any time: on the mobile control panel directly on the laser, via network connection in a control center, as well as over secured remote access.





HIGH EFFICIENCY WITH MULTI-KILOWATT POWER IN CONTINUOUS OPERATION

With more than 2,800 installations worldwide, the Laserline LDF diode lasers in the multi-kilowatt range are among the world's most successful beam sources for industrial applications. They have proven their worth in continuous operation, even under hostile ambient conditions such as high humidity or excessive metal dust content.

Technical advantages at a glance

The Laserline LDF diode lasers offers more power in less space than any other system in the multi-kilowatt range:

- World's only mobile series with up to 45 kW laser power
- Modular: Optional internal or external cooling system
- Laserline water/water or water/air cooling unit
- High electrical efficiency: Up to 50 percent
- Field-proven active diode cooling technology
- Internal networking of all system components
- Real-time diagnosis for errors
- Interfaces compatible with previous systems

4-exit beam switch





HIGH EFFICIENCY WITH MULTI-KILOWATT POWER IN CONTINUOUS OPERATION

Excellence in every respect

Whether welding, coating, hardening or brazing – the LDF series also scores with its optimally adapted beam quality and maximum user friendliness:

- Hot-pluggable capable mobile control panel
- Remote operation via network access
- Convenient laser data backup on USB-stick
- Easy maintenance thanks to sliding service hood
- Robust system for over 30,000 hours of operation
- Reliable continuous operation in multi-shift operation
- Industrie 4.0-conform communication via OPC UA
- 5 years warranty on laser diodes

Sturdy handles, built-in protection brackets



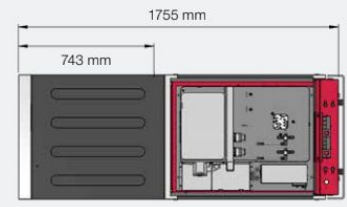
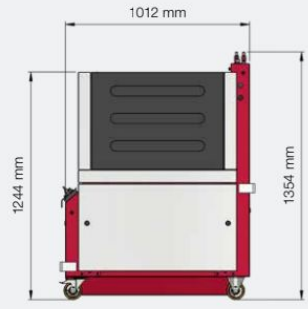

VG62

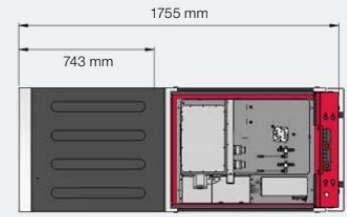
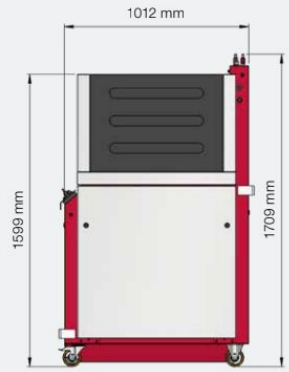

VG64

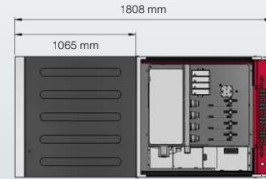
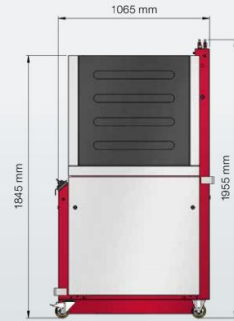

VG66

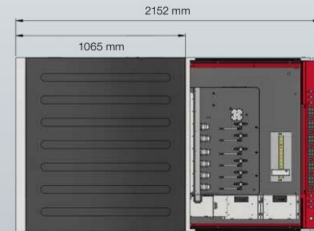
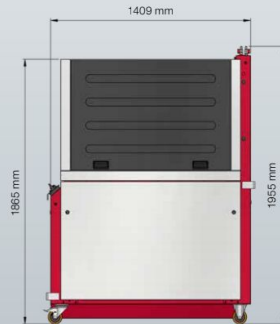

VG68

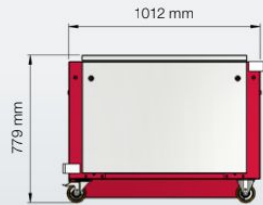

KG2

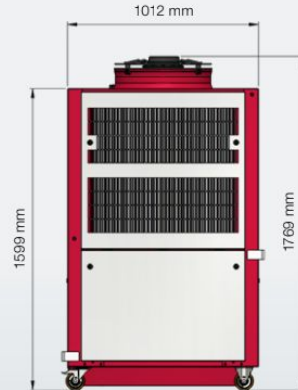

KG3



Optical specifications

Max. output power	8,000 W	11,000 W	16,000 W	22,000 W	45,000 W
Beam quality	30 mm mrad	40 mm mrad	60 mm mrad	100 mm mrad	200 mm mrad
	Other laser output powers available, tailored to the applications				
Optical fiber	600 µm [NA 0.1]	400 µm [NA 0.2]	600 µm [NA 0.2]	1,000 µm [NA 0.2]	2,000 µm [NA 0.2]
Min. focus at f = 150 mm	450 µm	600 µm	900 µm	1,500 µm	3,000 µm
Fiber-coupling unit	LLK-D/Auto, other types on request				
Fiber length	10 m, 20 m, 30 m, 50 m, 100 m, different lengths on request				
Power stability	< +/- 2% over 2 hours				
Wavelength range	900 nm to 1,080 nm				

Mechanical specifications

VG 62	Weight approx. 600 kg, dimensions: 1,012 x 680 x 1,244 mm ³ (L x W x H)
VG 64	Weight approx. 750 kg, dimensions: 1,012 x 680 x 1,599 mm ³ (L x W x H)
VG 66	Weight approx. 800 kg, dimensions: 1,065 x 850 x 1,845 mm ³ (L x W x H)
VG 68	Weight approx. 900 kg, dimensions: 1,409 x 1,227 x 1,865 mm ³ (L x W x H)



Connection data

Voltage	400 - 480 V \pm 10%, 3 Phases, PE, 50 or 60 Hz				
Power connection	Harting connector 32 A - 125 A (according to power consumption)				Terminal clamps
Power consumption, typical	25.5 kW	31.0 kW	43.5 kW	54.0 kW	112.0 kW
Cooling requirements, typical	17.5 kW	20.0 kW	27.5 kW	32.0 kW	67.0 kW
External inputs	Digital 24 V, analog power control 0-10 V, safety interlocks				

Cooling systems

Water / water heat exchanger	CHW40, 40 kW cooling power, water temperature: 10 °C to 16 °C
	CHW100, 100 kW cooling power, water temperature: 10 °C to 16 °C
Water / water compressor chiller	CCW12, 12 kW cooling power, water temperature: 15 °C to 35 °C
Water / air chiller	CCA12, 12 kW cooling power, water temperature: 38 °C
	CCA20, 20 kW cooling power, water temperature: 38 °C
	CCA35, 35 kW cooling power, water temperature: 38 °C



Operating conditions

Temperature	10 - 45 °C operational, 5 - 65 °C storage
Humidity	Max. 70% @ 25 °C, with humidity protection max. 80% @ 35 °C, non-condensing
Protection rating Safety class	IP 54 Laser safety class 1 according to DIN EN 60825-1

Options

Interface	PROFINET, Interbus-S, Profibus DP, DeviceNet, EtherNet/IP, EtherCat
Beam switch	Time Sharing or Power Sharing; 6 fibers (more configurations on request)
Optics	Laserline optics or commercial optics for every application
Others	Teleservice, pilot laser, pyrometer, CMOS camera, software for PC, mobile control panel, dust and humidity protection, water/water chiller with compressor, water/air chiller, optics chiller

Warranty and Lifetime

Warranty	5 years on diode laser elements, 2 years on laser system
Diode cooling	Active for highest power density and reliability
Uptime	Typically > 99.5%

Concerning functional safety, the laser conforms to DIN EN ISO 13849-1 and achieves the performance level d.



PROCESSING OPTICS OTS SERIES | CLADDING OPTIC

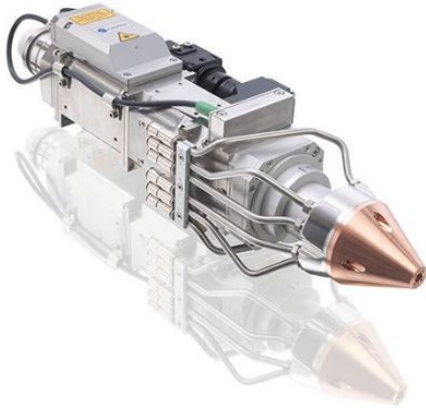

MULTI-STREAM NOZZLE

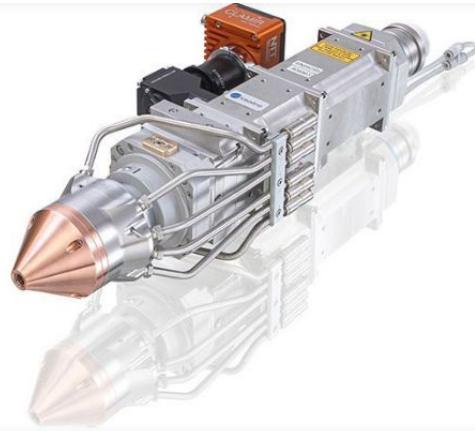

ROUND SPOT



WIDE STREAM NOZZLE



PROCESSING OPTICS OTS SERIES | CLADDING OPTIC

In the great selection of Laserline cladding optics for every application, a suitable tool can be found. For cladding, repair welding or additive manufacturing, different powder nozzles can be combined with the modular optic system from Laserline. Because of the various configuration possibilities, the process optic can be flexibly adjusted to different process requirements and boundary conditions. Furthermore, all available modules are optimally adjusted to Laserline's diode lasers, and therefore allow for process results that meet the highest quality demands.

Features

- Round and rectangular focus possible
- Typical applications: coating, repair welding, additive manufacturing
- Cladding with powder and wire
- Coaxial powder feeder with different nozzle geometries, integrated inert gas supply and cooling
- Protective window cartridge for simple and quick changes
- Angle of inclination up to 90° for 3-D processing
- Expansion level: integrated sensor for process monitoring

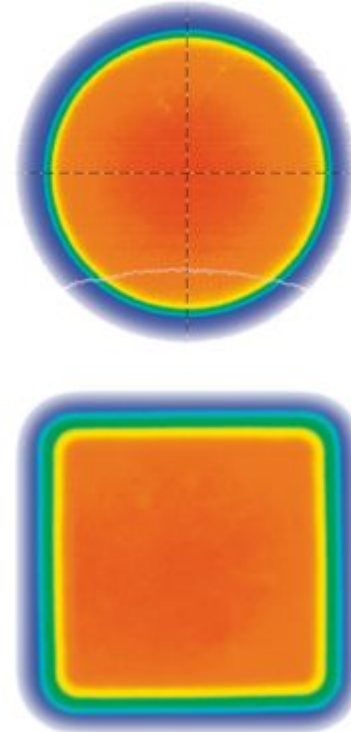



PROCESSING OPTICS OTS OPTICS | POWER ON THE SPOT

Modular, Robust, Variable

Laserline as your development partner works closely with you to design the optimal processing optics for your special requirements. Based on our broadly diversified construction kit our experienced engineers develop and qualify new optical beam shaping modules or complete optics for your special tasks and for integration in your system environment.

Variable in use

Laserline modular OTS processing optics boast a wide range of applications, from welding and brazing to surface treatment and the production of fiber composite components, including the fabrication of components in additive/subtractive manufacturing. This diversity of applications is enabled by a modular and highly flexible design.

Each optic can be adapted to most different application specific requirements to realise an efficient processing with high-quality results. The key to success often is the choice of a suitable focus geometry. A circular focus with homogeneous intensity distribution can be achieved through imaging of the fiber end and is typically used in applications such as metal and plastic welding, brazing or cladding. Line- and rectangular spots are obtained using homogenizing elements and may significantly increase the production throughput especially for the treatment of large workpieces. Therefore, these focus geometries are often applied in the field of heat treatment or cladding.

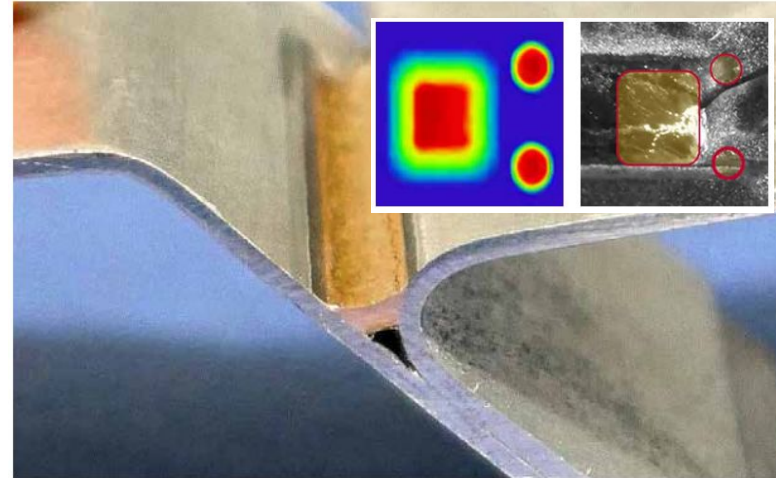

Triple spot brazing creates virtually perfect seams



PROCESSING OPTICS OTS OPTICS | POWER ON THE SPOT

Further focus geometries such as ring shapes, double or triple spots can be created with beam shaping elements or the Laserline multi-spot module. These spots are used for example for simultaneous welding or brazing of hot dip galvanised sheets. Beside the flexible focus geometry, different additional components such as cameras or sensors provide various possibilities to match the processing head to a certain process. Furthermore, beam deflection systems with total field sizes up to 400 x 400 mm² can be integrated.

Robust in continuous operation

Laserline optics are designed for industrial manufacturing processes. The fully internal cooling system and corrosion-resistant stainless steel housing in compliance with protection class IP54 allow continuous operation at high power up to 20,000 W even under difficult processing conditions. With the additionally available sensor package the condition of the optics can be monitored at any time. All sensor data is transmitted directly to the laser control and can be centrally evaluated and visualised.

- Modular versatility, flexible combination
- Robust construction for maximum loads
- Simple solutions for complex tasks
- Customer-specific focus shapes for all applications
- For welding, hardening and cladding
- Compatible with standard interfaces

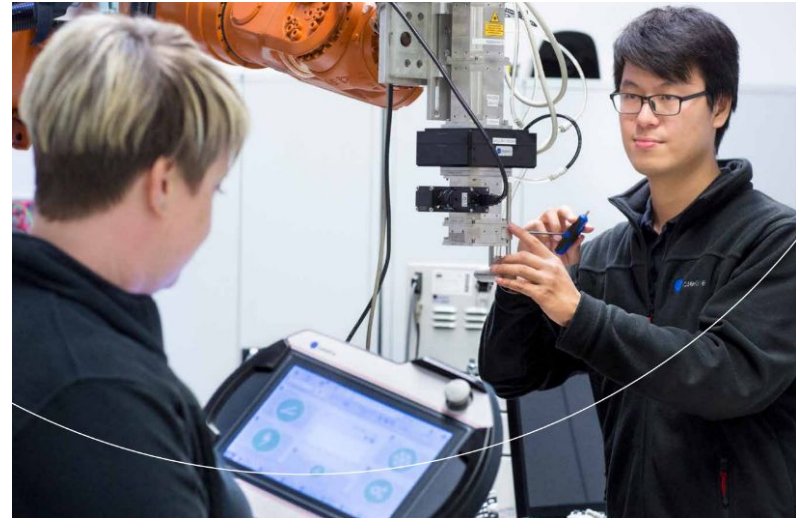



PROCESSING OPTICS OTS OPTICS | POWER ON THE SPOT

Individually designed

Due to the particular task, items of the modular OTS processing optics can be recombined, other components can be integrated or completely new systems can be developed.

These are perfectly customised for the particular application and are seamlessly adaptable to Laserline standard products. When Laserline delivers a customer specific solution, you are assured this solution will meet all requirements also in field operation.

Every new designed customer solution is thoroughly examined in the Laserline application lab and undergoes intensive endurance tests. All investigations take place in close cooperation with our customers. This allows a precise and practice-related understanding of the requirements.

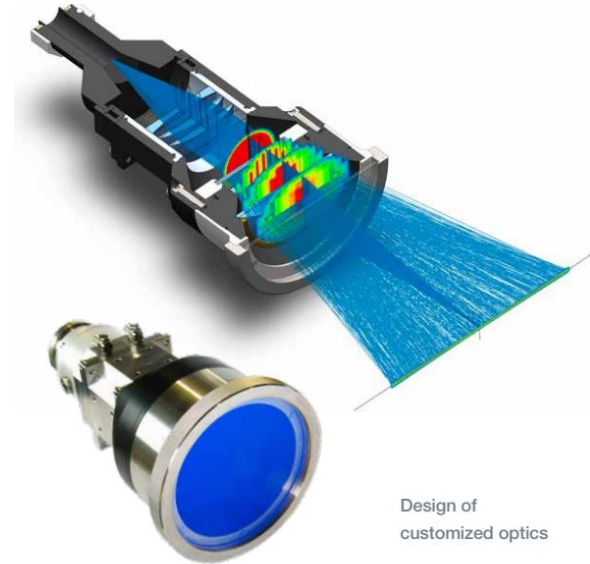

Design of
customized optics



PROCESSING OPTICS OTS OPTICS | POWER ON THE SPOT

The Laserline typical consistently modular system ensures investments and guarantees adaptability to new tasks and process parameters.

Modular design

The basic design of our processing optics consists of a standardised optical fiber connector LLK-B/-D (items 3 and 4), a collimating and a focusing lens (items 7 and 18, respectively). Thanks to a wide range of lens systems and equipment options, the Laserline system modules can be transformed into a tool optimally adapted to the particular application. The laser beam can be shaped into a focus with almost perfect homogeneity in energy distribution via a homogenizing element with special lens system (item 15) or into almost any possible focus geometry via the multi-spot module (item 17).

These optics can be supplemented by additional components, such as powder nozzles (items 22 and 23) or wire feed units. Numerous extensions are available to meet the requirements for a safe production process. The integration of coupling units (item 12 and 13) allows a utilisation of pyrometers (items 8 and 9) to measure temperature radiation or CMOS cameras (item 10) for process monitoring. A quick-change cover slide (item 19) allows the rapid exchange of contaminated cover slides, even in inaccessible parts of the system. By means of cover slide monitoring, it is also possible to monitor and visualise the degree of contamination.



Processing Optics OTS-3

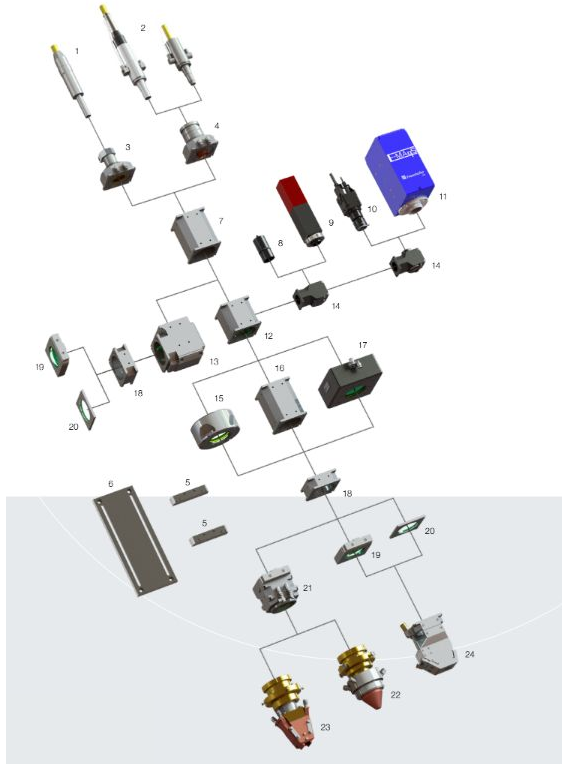

1. Optical fiber LLK-B
2. Optical fiber LLK-D (Auto)
3. Fiber connector LLK-B
4. Fiber connector LLK-D (Auto)
5. Optics socket
6. Base plate
7. Collimation optics
8. Interface for two color pyrometer
9. Single color pyrometer
10. CMOS camera
11. EMAqS camera
12. Coupling unit 0°
13. Coupling unit 90°
14. Adaptor for auxiliary components
15. Homogenizing element
16. Telescope optics
17. Multi-spot module
18. Focusing optics
19. Quick-change cover slide
20. Cover slide, standard
21. Water supply cladding nozzle/
Adaptor for M64 x 1.5 thread
22. Cladding nozzle
23. Rectangular cladding nozzle
24. Crossjet



Mechanical specifications

Optics	OTS-3	OTS-5
Optics dimensions, outside	56 x 56 mm ²	74 x 74 mm ²
Weight of standard processing optics* ¹	< 2.7 kg	< 4.7 kg

Optical specifications

Optics	OTS-3	OTS-5
Max. laser power* ²	12,000 W	20,000 W
Numerical aperture	NA 0.1 - 0.2	
Focal length collimation* ³	50 - 140 mm	70 - 200 mm
Focal length focusing* ³	100 - 500 mm	80 - 600 mm
Wavelength range	900 - 1,100 nm	
Fiber plug connector* ⁴	LLK-B, LLK-D/Auto	

Operating conditions

Ambient temperature	10 - 45 °C
Operating temperature	Max. 50 °C
Humidity	Non-condensing
Active water cooling	Recommended above 500 W cw

Auxiliary Components

Coupling unit	With and without 90° deflection of the laser beam
Interfaces	C-Mount, SM1, M40 x 1.5
Options	Homogenizing elements, crossjet, 90° beam deflection unit, cladding nozzle, ring-/twin-/telescope optics zoom, quick-change cover slide, cover slide monitoring, sensor package for condition monitoring

*¹ fiber connector, collimating and focusing optics, cover slide





*² higher power upon request

*³ other focal lengths available upon request

*⁴ other types upon request

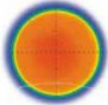



Standard spot geometries

Picture	Type	min. [mm]	max. [mm]
	Circular spot	0.2	30
	Line	0.2 x 4.0	1.0 x 135
	Square	2 x 2	135 x 135
	Rectangular 1:1 up to 1:18	3 x 5	9 x 135

Spot size depending on beam quality

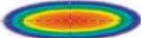
Special spot geometries

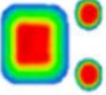
Picture	Type	min. [mm]
	Twin spot	Spot sizes and distance
	Ellipse	Size and aspect ratio
	Ring	Inner and outer diameter
	Triple spot	Exact spot geometry and power distribution

More configurations upon request



PROCESSING OPTICS OTS ZOOM OPTICS | ALWAYS THE PERFECT SPOT

Flexible. Dynamic. Modular

From laser beam source to the workpiece, Laserline offers industrial system solutions for laser materials processing. Processing optics that are perfectly attuned to our diode lasers are an important building block for the successful implementation of our customers' applications.

Flexibility in the focus

For many tasks of thermal surface treatment or small series production, laser system and processing optics must be flexibly adaptable to cope with a wide variety of different workpiece geometries. The matching Laserline system solution is an OTZ zoom optics with adjustable and homogenized focus. The OTZ-5 family is based on three different types of zoom optics to create variable circular spots (OTZ-5 VC), variable line spots (OTZ-5 VL) and rectangular spots (OTZ-5 VR) which can be adjusted in X and Y direction independently.

For all zoom configurations the intensity distribution remains homogeneous and ensures a uniform energy input across the entire track width. Long setup times due to the change and the alignment of optical systems can be avoided with the highly flexible system. In particular for applications like laser hardening the OTZ zoom optics provide huge technical benefits due to the flexibility as well as the homogeneous intensity distribution. The zoom range of OTZ-5 VC offers sufficient flexibility to realize both heat conduction welding and keyhole welding with one single processing head. Furthermore, this configuration is particularly suitable for ambitious cladding tasks, where variable track widths are required.

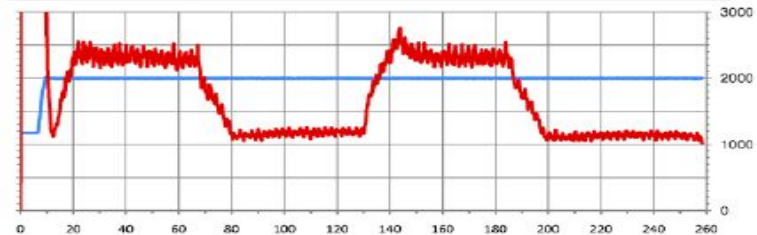
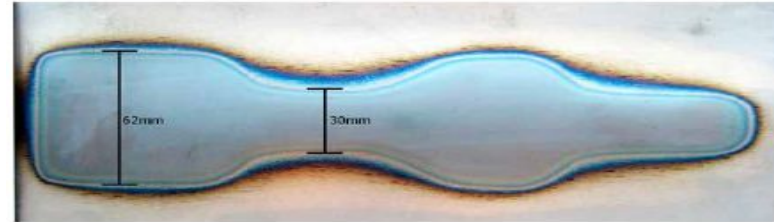

Temperature / Power regulation:
Constant surface temperature at variable
track width

Blue line = temperature curve
Red line = curve of laser output power



PROCESSING OPTICS OTS ZOOM OPTICS | ALWAYS THE PERFECT SPOT

Dynamics at the workpiece

The motorised adjustment of the optical elements allows a precise control of the spot radius, the track width or the focus length of the laser spot. Different processing tasks can thus be realised efficiently by dynamically changing the geometry in the X and Y direction – also during the ongoing laser process in closed loop-control of the laser.

Additional water cooling and integrated temperature sensors allow for continuous operation at high power of up to 20,000 W and multi-shift operation. In particularly dusty production environments, the stable housing according to IP54 as well as the optional sealing air protects the optics from contamination.

Raytracing of zoom optics

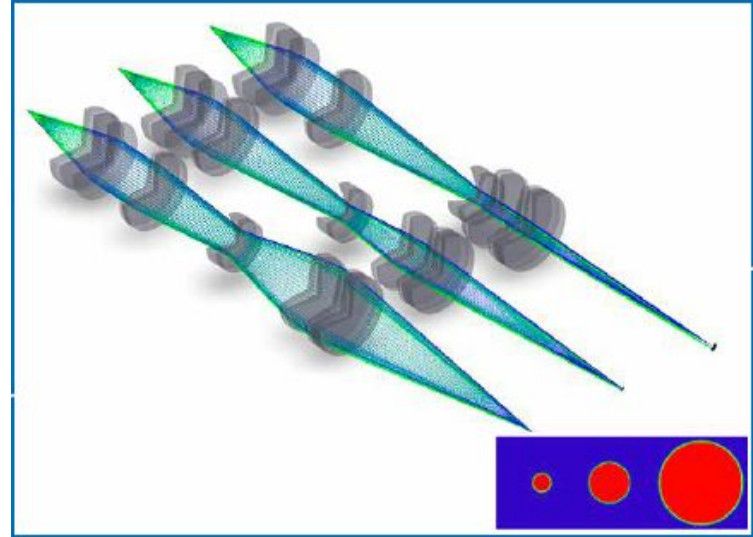



PROCESSING OPTICS OTS ZOOM OPTICS | ALWAYS THE PERFECT SPOT

The consistent modular system of the OTZ optics supports fast and cost-efficient realisation of customer specific solutions for special process requirements.

Modularity in the system

Due to standard interfaces, all three OTZ-5 variants can be flexible configured and combined with OTS-5 modules. Through the high degree of modularity it can be assured your optics is specifically tailored to your process requirements as well as your assembly situation.

A basic structure consists of a standard optical fiber connector LLK-B/-D (item 3 and 4), a collimation element (item 5), a motorised zoom optics (item 10), as well as a focusing lens (item 11) with protective cover slide (items 12 and 13). An optical pyrometer (items 7 and 8) can be integrated via the adaptor for auxiliary components and used for temperature-based laser power control for variable track widths. In order to meet the requirements of cladding applications, the integration of powder nozzles (item 17) is as well possible as the use of cameras (item 14) or other sensors for process control.

Control of the zoom optics is easy via an analog as well as an digital interface which allows the integration into the laser control. Thus the spot size can easily be adjusted via the laser control panel or a fieldbus interface of our laser.

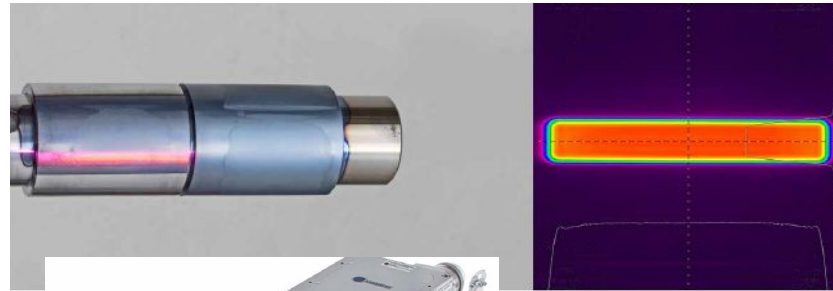

Flexible focus sizes for a variety of different geometries



OTZ-5VC zoom optics
with ringslit powder nozzle

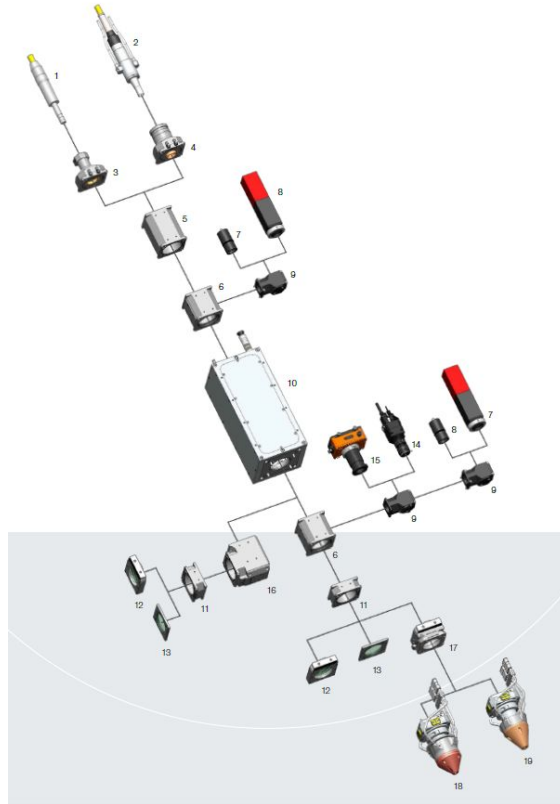

1. Optical fiber LLK-B
2. Optical fiber LLK-D (Auto)
3. Fiber connector LLK-B
4. Fiber connector LLK-D (Auto)
5. Collimation element
6. Coupling unit 0°
7. Connection for two color pyrometer
8. Single color pyrometer
9. Adaptor for auxiliary components
10. Zoom homogenizer
11. Focusing element
12. Quick-change cover slide
13. Cover slide, standard
14. CMOS camera
15. Clamir camera
16. Coupling unit 90°
17. Protective glass cassette for powder nozzle
18. Powder nozzle multistream
19. Powder nozzle ringslit



OTZ-5 VL (variable line), examples

Fixed spot size						
39	26	13				
19	13	6				
9	6	3				
3.3	2.2	1.1				
f 600	f 400	f 200	5	← → 58		
	f 400		10	← → 116		
	f 600		15	← → 174		
Variable spot size						

OTZ-5 VR (variable rectangle), examples

Var. spot size						
80	68	38				
↑	↑	↑				
↓	↓	↓				
17	11	6				
f 600	f 400	f 200	6	← → 38		
	f 400		11	← → 68		
	f 600		17	← → 80		
Variable spot size						

OTZ-5 VC (variable circle), examples

Fiber 200 μm	f 200	0.3	← → 0.9		
	f 400	0.6	← → 1.8		
	f 600	0.9	← → 2.8		
Fiber 400 μm	f 200	1.0	← → 3.2		
	f 400	2.0	← → 6.5		
	f 600	3.0	← → 9.7		
Fiber 1,000 μm	f 200	2.5	← → 8.1		
	f 400	5.0	← → 16.2		
	f 600	7.4	← → 24.3		
Variable spot size					



Laserline Zoom Optics

Mechanical specifications

Weight*1	< 11 kg
Dimensions*1 (L x W x H)	135 x 137 x 300 mm ³
Fiber connector*2	LLK-B (15 mm) LLK-D (Auto)

Optical specifications

Max. laser power*1	20,000 W
Numerical aperture	NA 0.1 or NA 0.2
Focal length	200 - 600 mm
Fiber diameter (LLK)	200 - 2,000 μm
Spot sizes	See below, more on request

*1 depending on configuration and zoom range

*2 other types on request

Operating conditions

Ambient temperature	10 - 45 °C
Humidity	Max. 85% non-condensing
Active water cooling	Recommended above 500 W cw
Motor control	Analog positioning operation (0 - 10 V), digital interfaces
Motor connection data	24 V, 3 A supplied by customer

Options

Auxiliary components	Pyrometer, CMOS camera, camera-based temperature control systems, powder nozzles
Coupling unit and interfaces	C-Mount, SM1, M 40 x 1.5 Option: 90°-coupling unit
Air supply	Sealing air



LASERLINE 20+ YEARS OF PROVEN CAPABILITY AND RELIABILITY

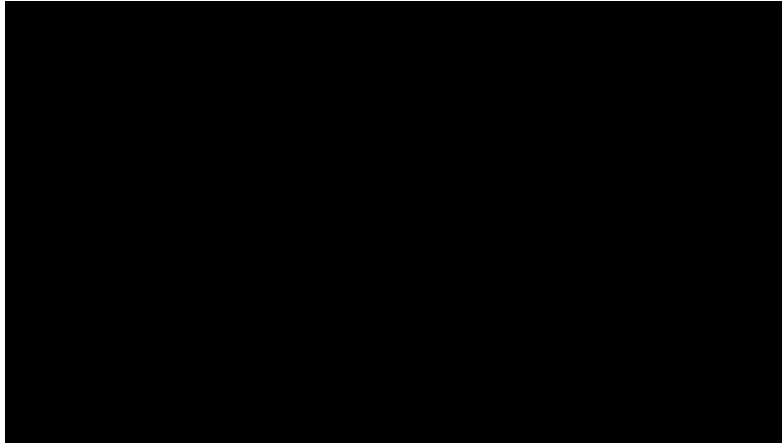

Since 1997, Laserline has been pioneering in the field of high power diode lasers for industrial materials processing. The company has an impressive track record of dynamic product line development and company growth. Laserline fibre coupled diode lasers are used in many different manufacturing processes around the world, with a well-proven capability and reliability for numerous applications.

They are incredibly efficient lasers, offering up to 25 kW power as standard. And they can achieve this with 50 per cent efficiency, meaning that for every 1 watt of output, only 2 watts of input is required. Laserline also supplies direct diode lasers for some specific applications like pumping and custom tasks.

What does Laserline manufacture?

Infrared fibre coupled high-power diode laser: Primarily used in Australia and New Zealand for cladding and metal deposition for the mining and gas/oil industries. Laserline's range of infrared fibre coupled high-power diode lasers is also suitable for welding, brazing, heat treatment, and other industrial applications such as CFRP tape laying. As well as offering incredible power and reliability, many of their systems are compact for reduced operational costs.

Blue fibre coupled high-power diode laser: Process highly reflective materials, such as copper or gold, with a stable melt pool. When compared to lasers in the 1-micron range, the materials absorb up to 20 times more of the 450 nm wavelength. New advancements such as heat conduction welding of thin copper foils is possible. Their use in hybrid applications allow you to weld thicker material without spatter.

Transform metal for greater strength: Laserline high power diode systems enable the creation of a new surface layer to the substrate. The use of a Laserline Diode Laser permits a controlled heat treatment process which is critical for cost saving for industries linked with repairs- E.g. mining, heavy industrial applications, power generation, and shipping.



TOUGH JOBS NEED TOUGH SURFACES

Laser cladding has fundamental differences when compared to other cladding technologies such as thermal spray, plasma coating, or arc welding. Using a Laserline high power diode system, a new surface layer is created with a different material to the substrate (the underlying surface).

A dense, pore-free, and extremely hard surface is firmly bonded, with little or no distortion to the part. This is critical to the types of industry that require this service, such as mining and power generation.

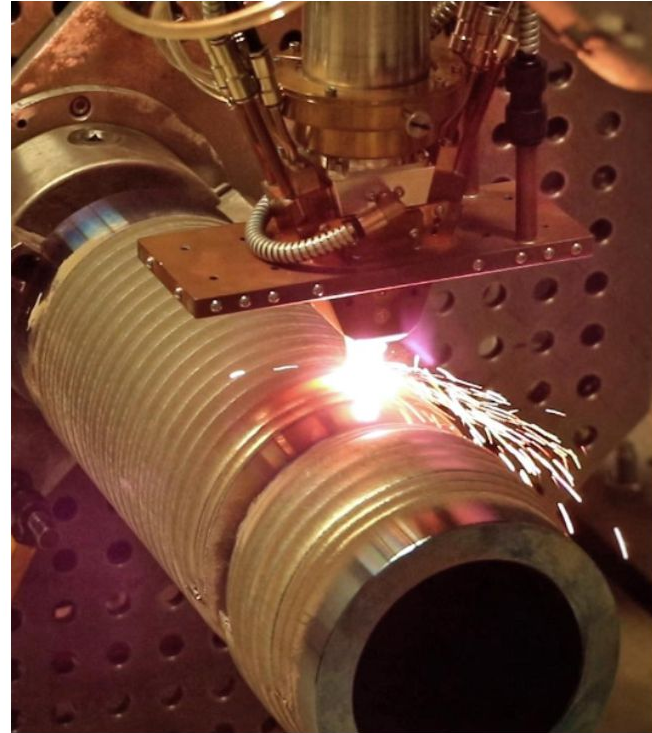



HOW CAN LASERLINE SYSTEMS HELP YOU INNOVATE?

Since 1992, our Laserline partners in Australia have been removing technical roadblocks for the industry. This could mean finding a more efficient, environmentally sustainable production process for you or using our lasers to create products that were previously unimaginable.

Whether you're a large multinational organisation or a small start-up, we can help identify a solution with our skills, experience, and diverse range of lasers. We also provide support for installation, training, and ongoing service.

Explore some of Laserline's successes from the past 30+ years in Australia in partnership with us.





THE CLADDING CHALLENGE

Large bearings, rollers, and other wear components present a significant challenge to the mining and energy industry. They're expensive to purchase and dispose of when worn. And it can be challenging to find replacements.

Laser cladding is an environmentally friendly, cost-effective way to resurface worn components used in the mining and energy sectors.

Raymax who is the Laserline Agent in Australia started working over 20 years ago with Laserline, the world's leading manufacturer of high-power diode lasers for industrial applications.

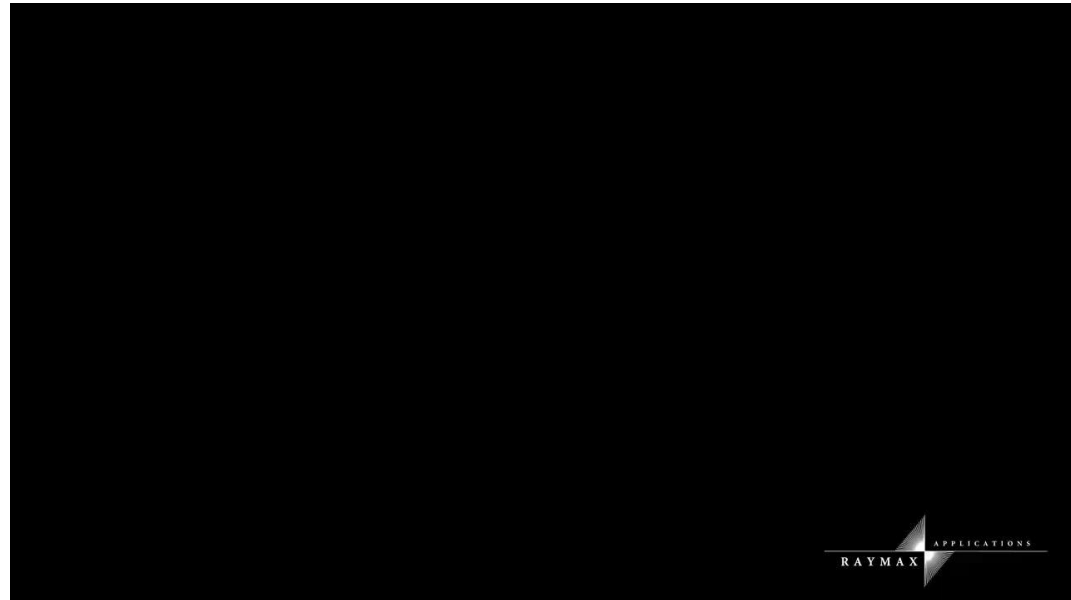



**SPECIALIST
MACHINERY
SALES** AUSTRALIA, NEW ZEALAND & SE ASIA

SUPERIOR SYSTEM TO MATCH YOUR APPLICATION

The high-power diode laser has revolutionised cladding repair. It offers high electrical efficiency and strong absorption by the clad powder and the base material. It's often 10x more efficient than previous technologies. Powers above 35kW are now commercially reliable and available and can deposit tens of kilograms of powder per hour, resulting in reduced cost to refurbish the part.

Additionally, the cost per watt of diode laser power has reduced significantly over the past two decades, further increasing the desirability of this technology. Using a laser system to recoat the worn surfaces with a hard layer renews the component. It's a cost-effective, local refurbishment capability that also minimises waste.

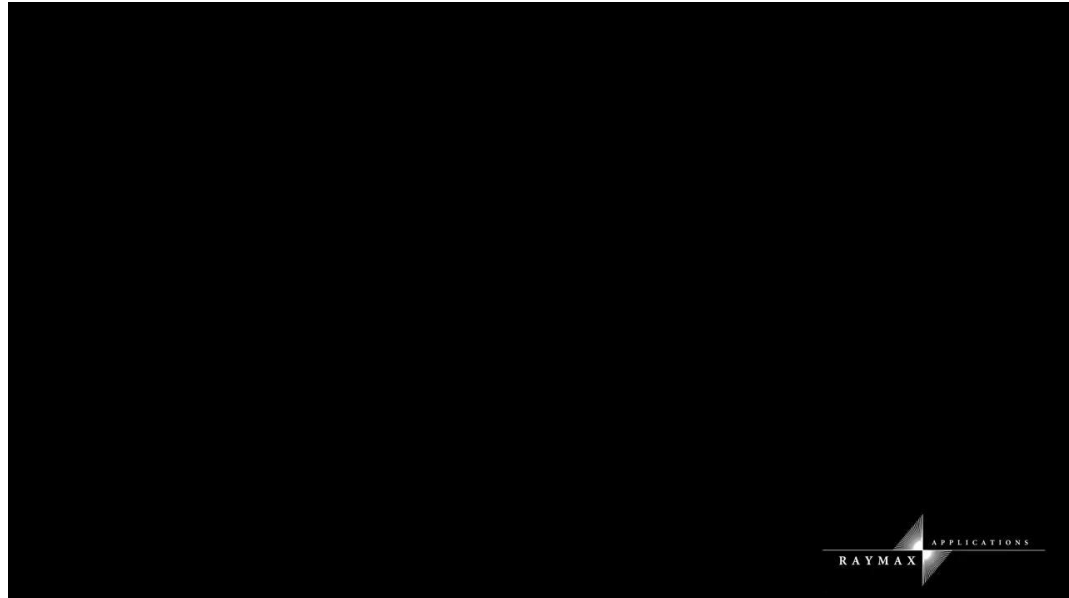



SUPERIOR RESULTS FROM MODULAR CAPABILITY

Raymax has customers in virtually all states using our laser diode and associated cladding technology to perform most reparation work in Australia.

Our customer base ranges from new startup organisations to established companies that have transferred from the older technologies to laser diodes. We also count universities and government agencies amongst our customers and look forward to supplying them with even higher power and different wavelength solutions in the future.





**SPECIALIST
MACHINERY
SALES** AUSTRALIA, NEW ZEALAND & SE ASIA

20+ YEARS OF PROVEN TRACK RECORD IN INSTALLATION, TRAINING, WARRANTY, SERVICE, AND CONSUMABLES

Raymax Lasers offer some of the world's best laser solutions for laser cladding from Laserline GmbH. There are 2 types of laser that are suitable—the fiber-coupled LDF diode laser and direct diode lasers. We can help you determine which laser is best suited to your needs.

Beyond the superior products we supply, you'll also get access to factory-trained engineers to assist with the installation, material interaction processes and ongoing support to keep you running.

IMPORTANT

Within Western Australia, there are stringent regulatory laws and qualifications that make accreditation a mandatory requirement for the installation, training, servicing, and warranty support of any system. Rest assured, both Raymax (Laserline's partner) and Specialist Machinery Sales are fully qualified to meet these stringent standards.

Raymax boasts the expertise of two laser physicists serving as directors, a testament to their exceptional technical prowess. In fact, Laserline regards them as among the world's most formidable and esteemed technical agents.

Raymax is available to discuss their technical expertise and experiences to assist with specifying the fit-for-purpose diode system, including service and support.





**SPECIALIST
MACHINERY
SALES** AUSTRALIA, NEW ZEALAND & SE ASIA

WHY RAYMAX?

We make laser light work for you. We've spent over 30 years demonstrating what's possible with lasers. In doing so, we've helped modernise Australian and New Zealand industries. You'll be working with a team of physicists and factory-trained engineers—leaders in the supply of laser solutions and photonics equipment. We're experts in material interaction research.

Wherever possible, you'll be introduced to new technology that can improve operation in ways you might not have imagined possible.

The team at Raymax have offered us exceptional service and technical back up. We couldn't ask for better support from a supplier. - Ben Sonsee, General Manager at CGC Engineering

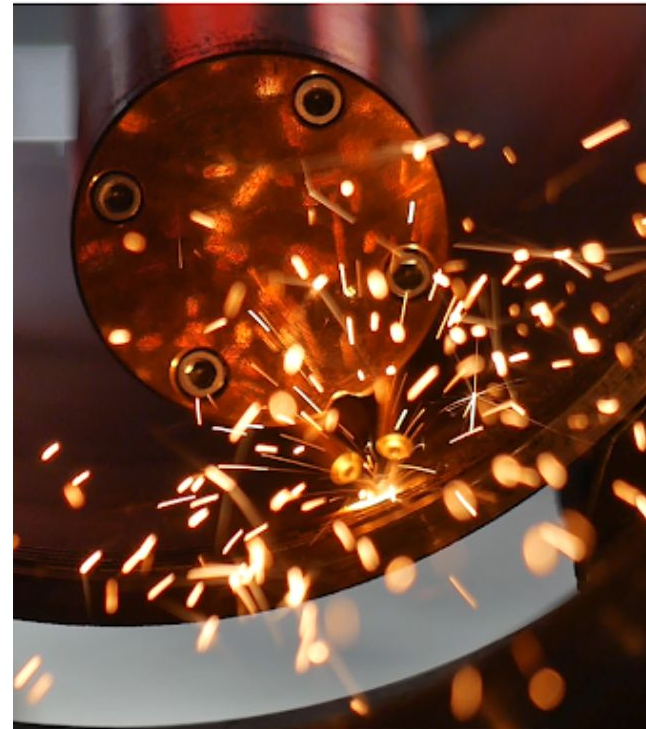



PROCESSING HEADS

ALOHARD

This processing optics for laser hardening has a fixed laser track width. It is compact, light and at the same time robust in the process.

ALOhard can be integrated in all our laser systems. Moreover, since it is a component of our modular system configurations it can be used alternately with other optics, such as for example ALOpowder for laser cladding by powder.





PROCESSING HEADS

ALOHARD

Laser hardening is a surface hardening process that achieves maximum hardness values at the component surface with a very low energy input. This enables a direct improvement of the wear behaviour of components. The laser beam briefly and precisely heats the upper area of the material, forming an austenitisation front.

Due to the self-quenching effect, depending on the volume, no separate quenching medium is required and the rapid cooling leads to the formation of martensite. Due to its technology, laser hardening is very environmentally friendly, resource-saving and very economical, especially in the area of small series and individual pieces.

Technology for all shapes

Depending on the geometry of the component, different machining optics ensure the optimum surface hardness.

ALOhard

This processing optics ALOhard for laser hardening has a fixed laser track width. It is compact, light and at the same time robust in the process.

Application: Laser hardening with a fixed track width of simple serial parts used in the field of mechanical engineering as well as on tools and molds.





PROCESSING HEADS

ALOHARD

Technology for all shapes (continued)

ALOhardzoom

The ALOhardzoom processing optics enable flexible change of the laser track width in x- and y-direction during the hardening process.

Application: Laser hardening with variable track width of geometries from a wide and changing spectrum of tool and mould components as well as parts for mechanical engineering.

ALOhardscan

With ALOhardscan we provide our clients the ultimate tool for the most demanding hardening processes. A dynamic, scan-like pendulum movement is generated via an oscillating mirror, which creates the condition for highly efficient heat field control.

Application: For all laser hardening processes, independently of the geometry of the component. Example for radii, V-grooves, multiple steps and planes, along an edge or any components geometry of parts from batch size 1 to many in tool and die industry as well as in the field of mechanical engineering.



LASER HARDENING OF A CYLINDER WITH ALOHARDZOOM



PROCESSING HEADS

ALO HARD

Advantages of laser hardening

The advantages of laser hardening are convincing: high surface hardness for improved wear behaviour up to economic efficiency even for single pieces.

- Low weight for robots with a lower load capacity
- Compact structural form and less interference contours
- Rectangular focus with homogeneous intensity distribution of laser beam
- System for quick replacing of cover slides.

Mobile on site laser hardening at the component. Ask us!



Laser power control
for a homogeneous
hardness profile



High surface
hardness up to
65 HRC



Minimal distortion
due to small heat
input



Flexible shaping of the
laser beam



Energy efficient and
environmentally friendly



Time saving



Area rate up to
0.5 m²/h



No quenching media
required



Small batches and
single pieces



PROCESSING HEADS

ALOHARD

Advantages of laser hardening (continued)

- Applicable to all directly hardenable steels
- Smallest possible distortion due to low heat input with high energy saving potential
- Self-quenching process - no environmental impact
- Hardening of defined areas on the workpiece surface
- Spot hardening on knobs and in blind holes
- Real-time laser power control for a homogeneous hardness curve
- Surface hardness up to 65 HRC
- Area rate up to 0.75 m²/h
- Minimal distortion due to low heat input
- Flexible shaping of the laser beam

**Hardening of steel in tool and mold making as well as in general mechanical complexity
- applicable to individual and series components.**

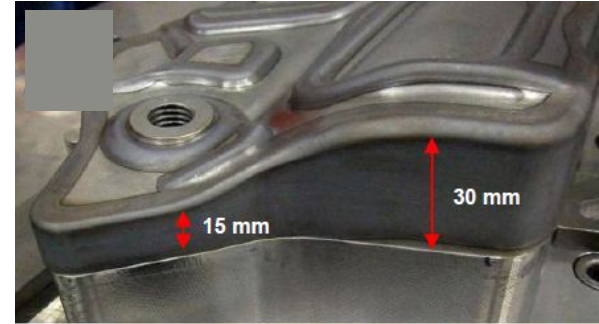



PROCESSING HEADS

ALOHARD

Applications of laser hardening

ALOHard ensures maximum hardness values on highly stressed component surfaces and is therefore an important factor for industry, mechanical engineering and toolmaking.

ALOHard laser hardening is used for the finishing of highly stressed, complex components. Maximum hardness values are generated on the component surface with a low energy input. This results in a targeted improvement in the wear behaviour of heavily stressed component surfaces.

Laser hardening is used in industry, automotive, railways, mechanical engineering, toolmaking, mould making, the oil and gas industry, mining, shipbuilding and agriculture.

Special service: We harden on site!

We offer laser processing by means of laser hardening ALOHard as well as laser cladding by powder ALOpowder directly on site. It eliminates the transport times and the associated costs and risks.

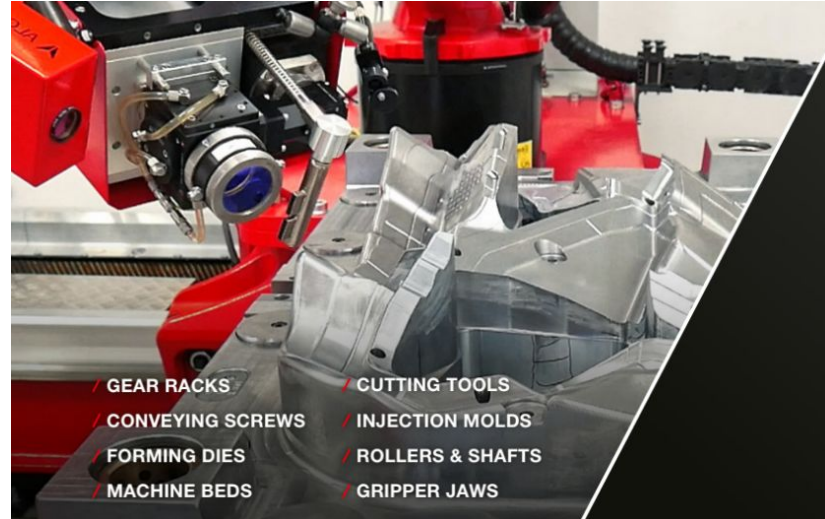

- / GEAR RACKS
- / CONVEYING SCREWS
- / FORMING DIES
- / MACHINE BEDS
- / CUTTING TOOLS
- / INJECTION MOLDS
- / ROLLERS & SHAFTS
- / GRIPPER JAWS



PROCESSING HEADS

ALOHARD

Examples for laser hardening

Due to our different optics, we can process all components regardless of their geometry.

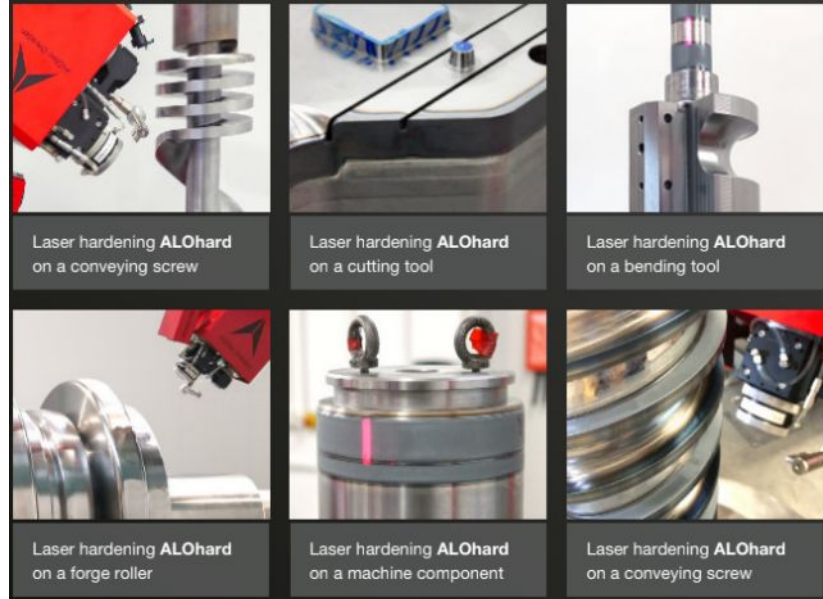



SUPPORT AND CONSULT

01

Maintenance

- Training for independent maintenance of the system (English / Italian / Polish / Spanish / alternatively in any language with an interpreter)
- Maintenance including inspection at set intervals

02

Inspection

- Remote maintenance (optionally with AR support)
- Maintenance at our customers' site

03

Repair after maintenance (collaboration with selected suppliers)

- Via AR support
- Maintenance at our customers' site

04

Increasing system capacity

- Increasing system capacity and ensuring the customer's production capability we provide systems as an extended workbench during peak order times



**SPECIALIST
MACHINERY
SALES** AUSTRALIA, NEW ZEALAND & SE ASIA

YOUR MACHINERY OPTIONS

PRE-FABRICATION / STEEL PROCESSING

Specialist Machinery Sales (SMS) provides a wide range of prefabrication machinery designed to assemble steel components with precision and efficiency.

Our comprehensive selection includes bandsaws, beamlines, coping robots, plasma cutters, pipe rotators, and shotblasting machines. With our cutting-edge machines, you can streamline your steel fabrication process and ensure seamless on-site erection.

LEARN MORE HERE ►





**SPECIALIST
MACHINERY
SALES** AUSTRALIA, NEW ZEALAND & SE ASIA



BANDSAW



**BEAMLINE AND
COPING ROBOT**



CIRCULAR SAWING



**FLATBAR AND
ANGLE LINES**



**PLASMA CUTTING
AND DRILLING**



**PIPE ROTATORS AND
PIPE WELDING**



**PLATE AND SECTION
ROLLING / BENDING**



SHOT BLASTING

YOUR MACHINERY OPTIONS

FABRICATION / WELDING

Fabrication machinery plays a vital role in manufacturing steelwork components that form complete frames and structures. At Specialist Machinery Sales, we provide top-of-the-line machinery for beam/robot welding, steel beam assembly, and welding. With our high-caliber equipment, your workshop can achieve full automation, productivity, and efficiency.

Explore the options below to discover the range of machines that can elevate your fabrication processes to new heights.

[LEARN MORE HERE ►](#)





**BEAM WELDING /
ROTATION**



**LASER CLADDING /
WELDING / HARDENING**

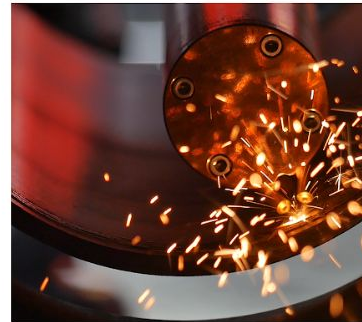

**LASER
SYSTEMS**



**BEAM PROFILE LAYOUT
LASER MARKING**



**SPECIALIST
MACHINERY
SALES** AUSTRALIA, NEW ZEALAND & SE ASIA

YOUR MACHINERY OPTIONS

POST-FABRICATION

Post-fabrication is a crucial stage in ensuring the highest quality for steel structures. At Specialist Machinery Sales, we have partnered with renowned European brands specialising in shotblasting and painting systems, bringing you top-notch solutions.

Choose from a wide range of shotblasting and painting systems, powder coating systems, and zinc spraying systems from industry-leading brands like Kaltenbach and SLF. These cutting-edge technologies will enhance the durability, aesthetics, and overall performance of your steel structures. Take your fabrication process to the next level with our comprehensive post-fabrication solutions.

[LEARN MORE HERE ►](#)





PAINTING SYSTEMS



SHOT BLASTING



**SPECIALIST
MACHINERY
SALES**

AUSTRALIA, NEW ZEALAND & SE ASIA

OUR INDUSTRY SOLUTIONS

Specialist Machinery Sales provides our clientele with a full range of structural steel machinery options for industries such as steel construction/fabrication and steel service centres.

Aside from these, we are proud to showcase a variety of steel processing machines for different sectors under the steel manufacturing industry like 5G Poles, Power Transmission Towers, Shipyards, Metal and Machine Construction, Bridge Building, Aviation, Agricultural Machine Engineering, and the Automotive sector, just to name a few.

[LEARN MORE HERE ▶](#)





STEEL FABRICATION

We offer cutting-edge solutions to upgrade your traditional factory into a smart and automated steel production facility.

From advanced blasting and painting processes to precise cutting and welding techniques, our technology-driven solutions will revolutionise your manufacturing capabilities.

Unlock the potential of efficiency, productivity, and quality in your steel production.

LEARN MORE HERE ►

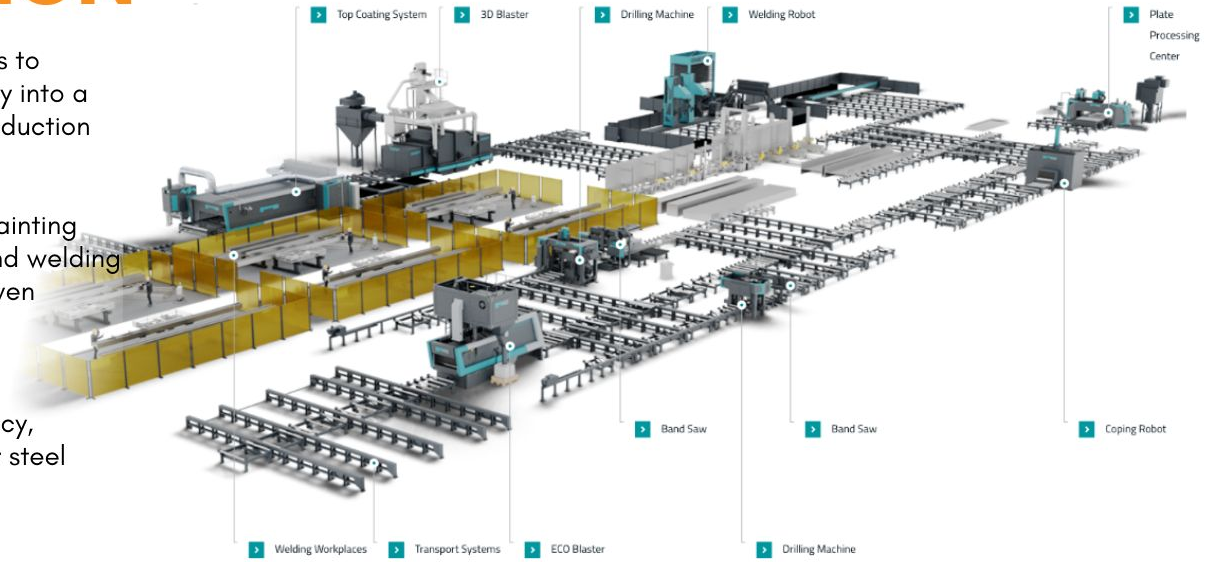



METAL CONSTRUCTION

Experience optimum flexibility in metal construction with our easy cutting capabilities for box sections, small profiles, and larger parts.

Our fast, precise, and comfortable sawing, combined with a high-performance drilling system, ensures efficient operations.

Count on us to find the perfect solution for your requirements, delivering safety, effectiveness, and reliability.

LEARN MORE HERE ▶

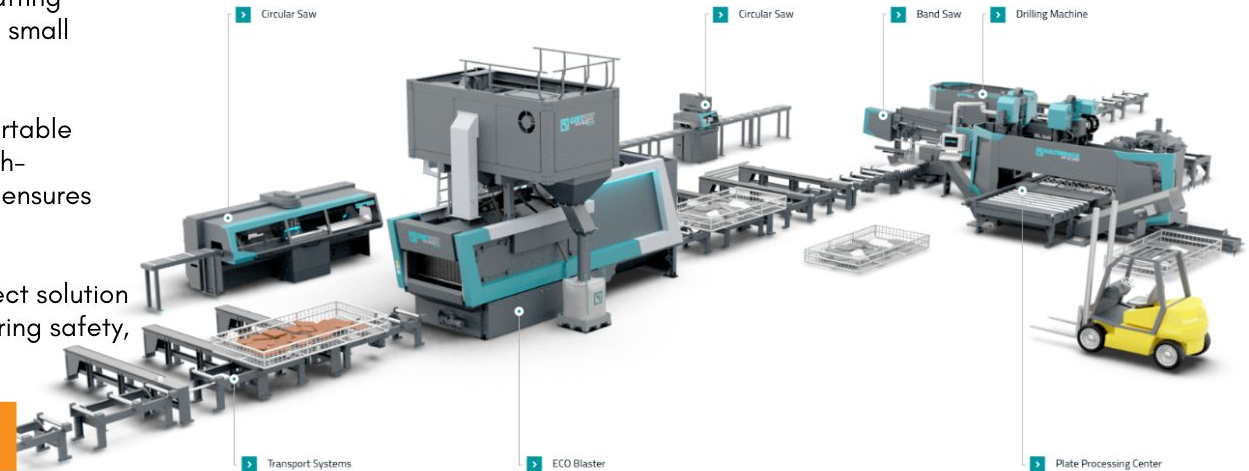



BRIDGE BUILDING

Experience the power of our unique machine combination for producing plates and profiles with precision holes and welding edges.

Our solution offers the highest efficiency and eco-friendly operation, enabling you to achieve the lowest cost of ownership. Take your production to the next level with us.

[LEARN MORE HERE ▶](#)

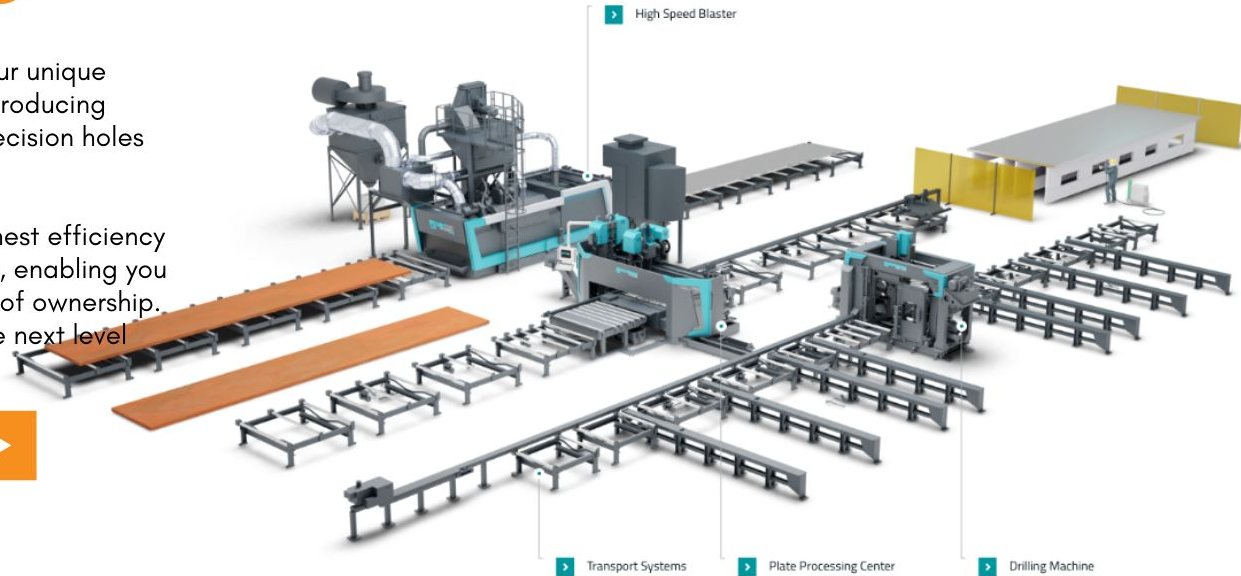



STRUCTURAL ENGINEERING

Our advanced line brings your designs to life with precision. From blasting to sawing, drilling, milling, cutting, and coping, we process single parts with utmost accuracy.

Effortlessly weld the parts together, and then experience exceptional end products through our cleaning and painting processes.

LEARN MORE HERE ▶

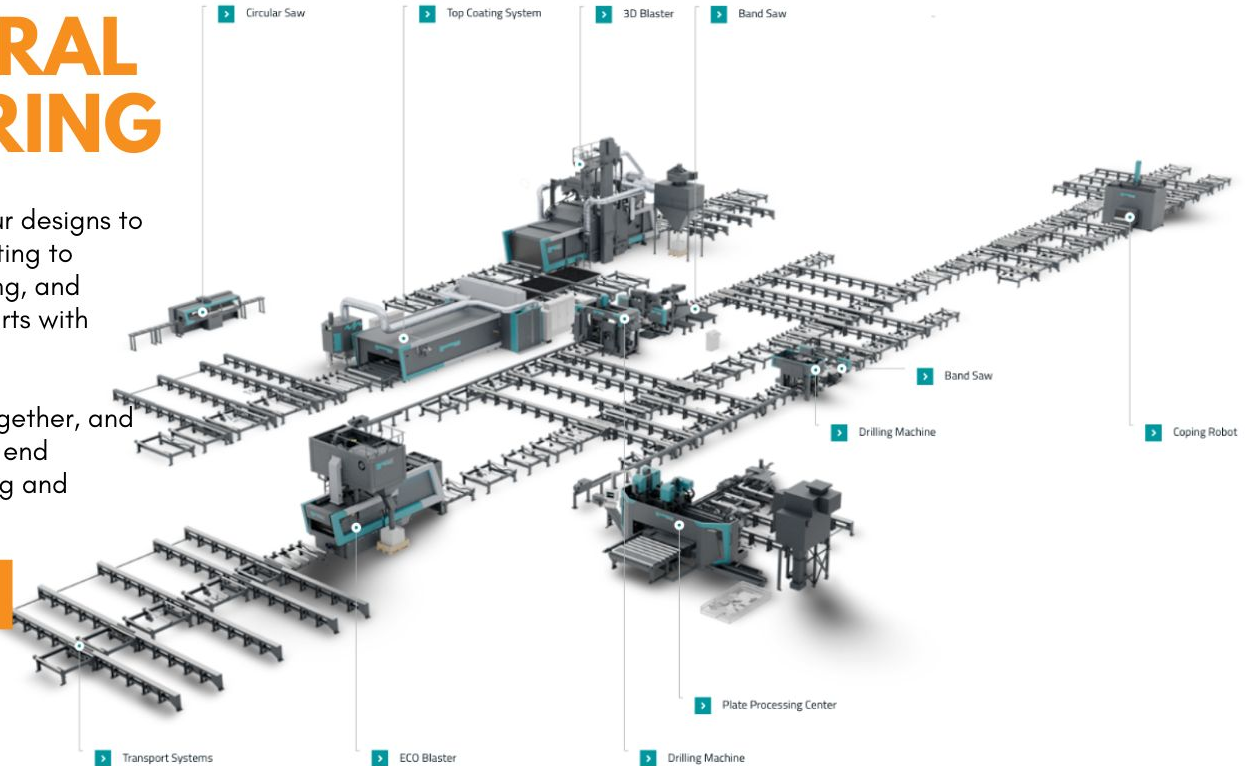



STEEL SERVICE CENTRES

Achieve success by leveraging the power of our machinery. With our automated solutions for sawing, drilling, milling, and coping, you'll enhance your business capabilities.

After precision processing, our shotblasting and painting techniques ensure a protected and impeccable surface finish. Experience the difference and take your business to new heights.

[LEARN MORE HERE ▶](#)

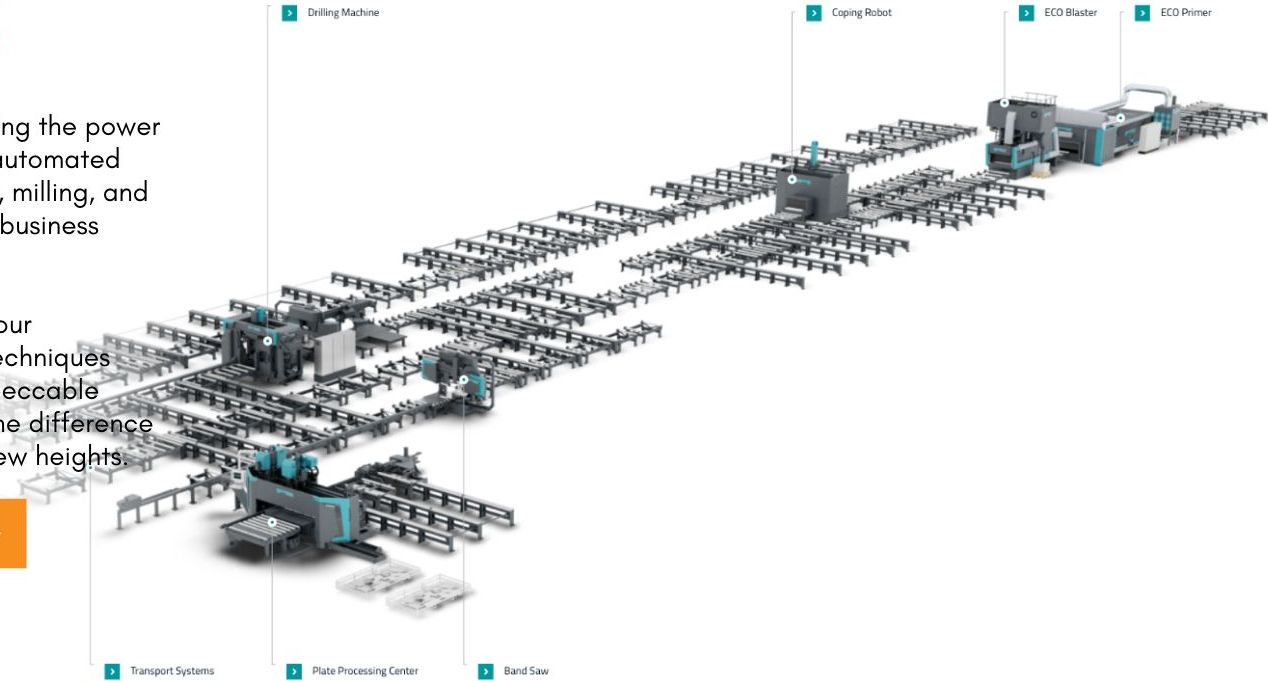



TRANSMISSION TOWERS

Need slot holes in your steel? Our drilling machine KDP, equipped with movable axes and 12 tools/axis, ensures fast and efficient milling of slotted holes.

Looking for multiple connection holes? Our KF 2628 with double drilling and plasma axis is designed to handle the production of numerous plate parts with ease.

Trust in our cutting-edge machinery to streamline your steel fabrication process and meet your exact specifications.

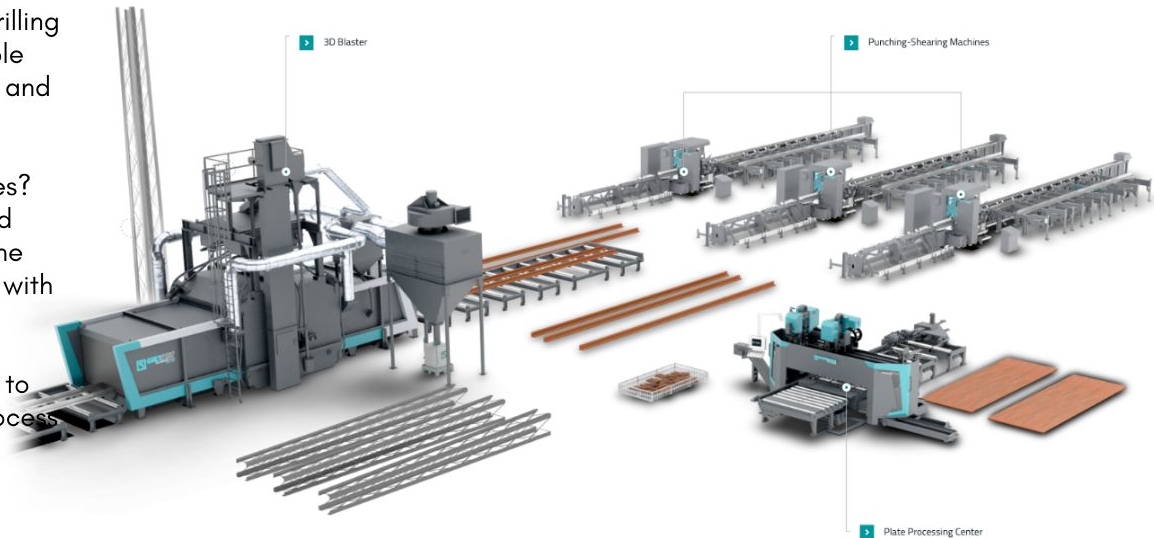

LEARN MORE HERE ▶



CRANE BUILDING

When it comes to steel processing, reliability, experience, and flexibility are paramount. That's why we offer top-of-the-line machinery specifically designed for the crane building sector.

With our solutions, you can ensure total protection against corrosion for steel structures, including surface preparation and coating.

[LEARN MORE HERE](#) ▶

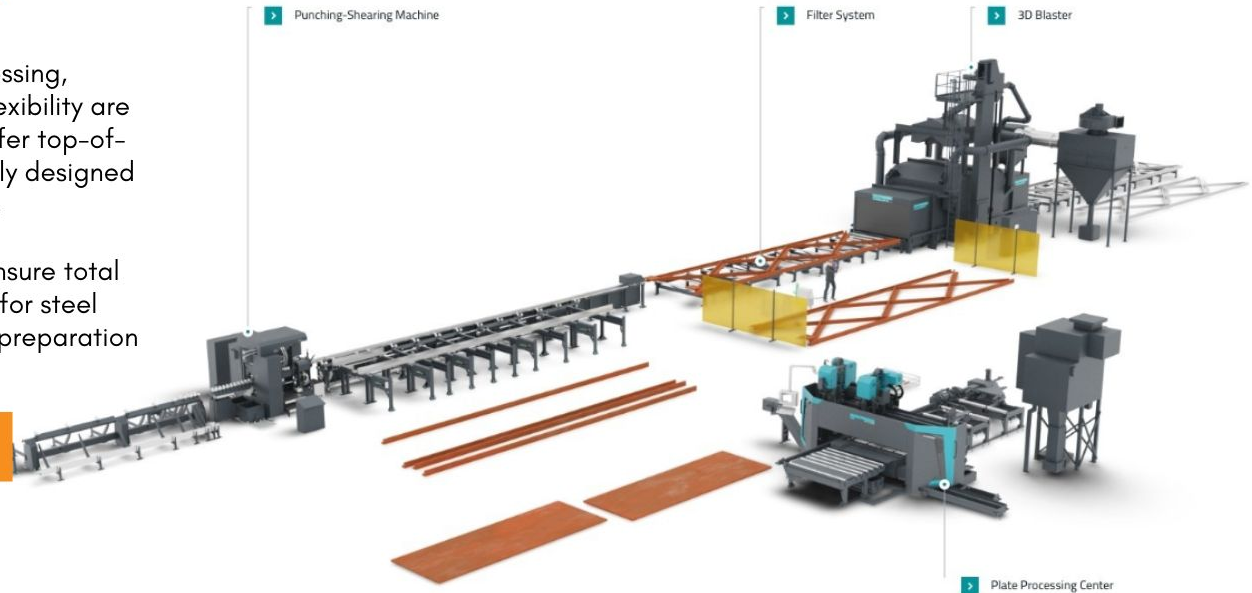



AUTOMOTIVE SECTOR

Experience high precision in automotive component manufacturing with our state-of-the-art machinery. Our advanced processes, including shotblasting, sawing, drilling, oxyfuel, and plasma cutting, are tailored to produce top-quality products.

Each item is meticulously crafted according to your specifications, complete with precise identification marks made by our scribing tool or hard stamp unit. Trust us to bring your drawings to life with perfection.

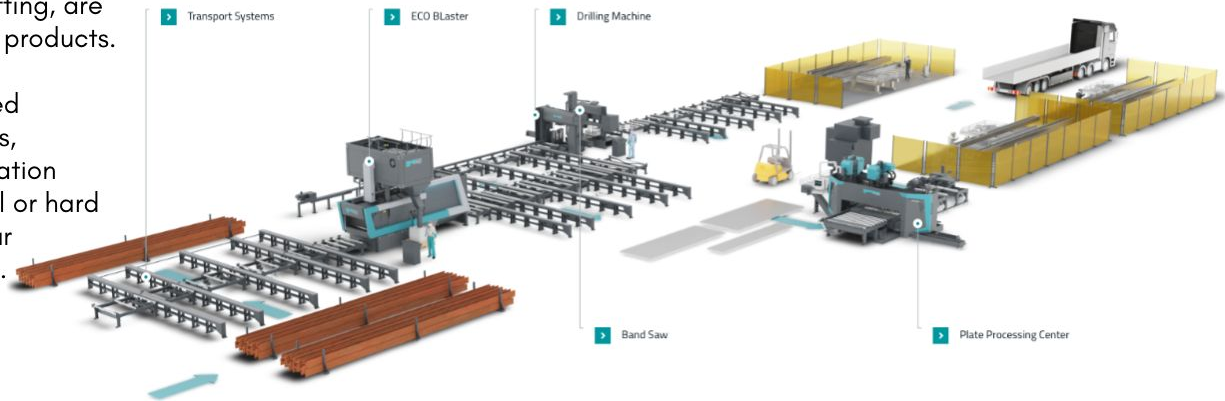

LEARN MORE HERE ▶



SHOT BLASTING AND PAINTING LINE

Achieve high blasting efficiency and reduce paint consumption with our cutting-edge combined systems. We prioritise cost-effectiveness in your production processes, offering the lowest overall cost without compromising on quality.

Our integrated systems are designed with durability, versatility, and user-friendliness in mind. Experience seamless operation, easy maintenance, and exceptional performance, ensuring maximum productivity and efficiency for your business.

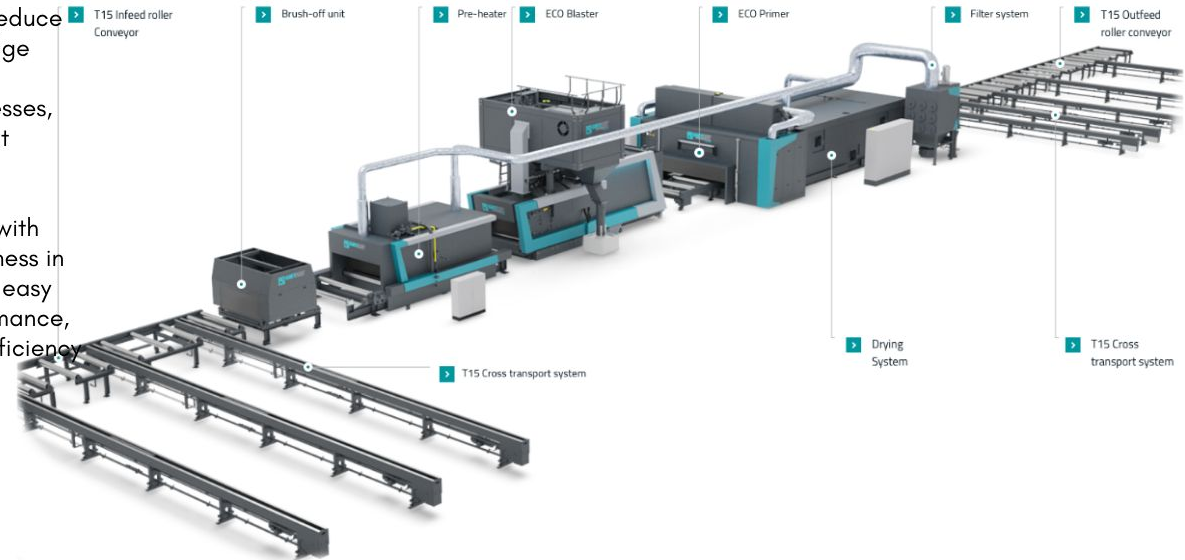

LEARN MORE HERE ▶



COMPACT BLASTER WITH SAW DRILL LINE

Discover a powerful and fully reliable system that delivers high-quality and cost-effective surface treatment. This system is the perfect complement to your single Saw Drill and Coping line, providing a comprehensive solution for your production needs.

Experience the benefits of seamless integration and streamlined operations, ensuring efficient and precise surface treatment. With our system, you can achieve superior results while optimising costs, maximising productivity, and maintaining exceptional quality standards.

[LEARN MORE HERE ▶](#)

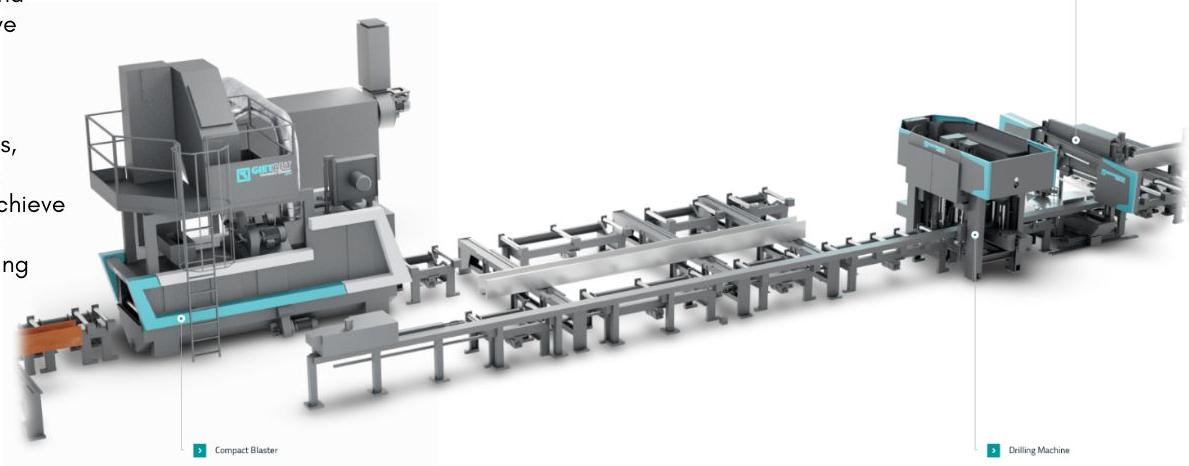



**SPECIALIST
MACHINERY
SALES**

AUSTRALIA, NEW ZEALAND & SE ASIA

WHY PARTNER WITH SMS?

Specialist Machinery Sales (SMS) is a complete system and solution provider. SMS proudly offers the complete material handling to meet our client's material flow pain points and challenges; thus, innovating the traditional material flow of a fabricator's workshop- fabrication/assembly and welding out prior to shot blasting and painting.

We are proud to be the only partner in Australia and New Zealand who can provide a complete system and integrate these machines from steel processing for all steel profiles and plate.

We partner with only the best and superior machine tool builders that have been market leaders of innovation and automation to the steel industry. We strongly believe that the future for our clients and the steel industry is to link the various machines and technologies, software, material handling, and automation together.

This is now possible with a mix of new and pre-loved machines that can be integrated into the material handling ecosystem and footprint available when partnering with SMS.





**SPECIALIST
MACHINERY
SALES**

AUSTRALIA, NEW ZEALAND & SE ASIA

AUTOMATED SOLUTIONS FOR EACH LEVEL OF REQUIREMENT

Many years of experience and high innovation rates enable us to set the standard in the industry, especially in the areas of sustainability and cost effective processing. As a trend setter and technology leader, we are able to supply premium quality solutions, combined with an attractive and functional machine design.

Our product ranges bring total solutions and special machines for sawing, drilling, plate processing, as well as shot blasting and painting, including logistic and control systems. Powerful, highly versatile systems, whereby quick return on investment is made possible by means of a high level of performance and productivity.

Process optimisation and a wide range of automation possibilities enable an individual adjustment of production and transport processes, according to your requirements. From unique machine software to complete management information systems, SPECIALIST MACHINERY SALES is your specialist machinery partner.



WHO PARTNERED WITH SMS?



Ace Construction Australia



NAVAL
GROUP



DUNSTEEL



BEDFORD
ENGINEERING LTD



WHO PARTNERED WITH SMS?





CSF INDUSTRIES INVESTS IN ITS FUTURE WITH SUPERIOR MACHINES EXCLUSIVELY SUPPLIED BY SPECIALIST MACHINERY SALES

A family business established in Cairns in 1979, CSF Industries operates across just about every market imaginable, from mining and defence, through to commercial, industrial and residential.

Their order book regularly encompasses everything from \$3,000 steel supply contracts to \$10 million multi-faceted project delivery.

With such variety, CSF Industries is agile and versatile and has built a reputation for excellence in service and quality. CSF Industries recently worked with SMS to invest in a Superior Structural Steel Automation Beam Assembly and Welding machine plus an add-on-part robotic sorting machine plus a fully-automated beam line working in lights out operation and plate plasma cutting, drilling, stamping, punching, material handling, plate processing machine to ensure that they remain at the forefront of industry.

According to Sean Adams (Director, CSF Industries) "We've invested a lot in technology, processes and procedures throughout the workshop. To do this, we first identified the bottlenecks: sorting parts was one. The add-on-part robotic sorting machine have removed this bottleneck. It performs quality assurance checks and sorts parts unto column and rafter numbers so they are delivered to the fabricator, ready to go."

"The Superior Structural Steel Automation Beam Assembly and Welding machine removes all these issues- it removes downtime from the production process, improving productivity throughout the entire workshop," said Sean.

THE RESULTS

Sean was equally as impressed with CSF Industries' newly purchased Superior Structural Steel Automation Beam Assembly and Welding machine. According to Sean, it has improved on-site rework considerably. "The machine helps us to guarantee the quality of our work. We get a lot of repeat business due to our quality standards and lack of rework."

"Another of the advantages of this superior machine is the consistency of labour that it delivers. We have our machine working on two shifts, for 18 hours a day. In a skills shortage environment, this is really important. We have the confidence that the machine will be there, operating day in, day out. This allows us to commit to jobs we might not have been able to because of the labour component."



PAGE STEEL FABRICATIONS: FUTURE PROOFING VIA AUTOMATION WITH SPECIALIST MACHINERY SALES (SMS)

Page Steel Fabrications was established in Victoria in 1970. Over the last 50 years, the company has expanded significantly, adapting to the rapidly changing nature of the industry with the implementation of advanced software and cutting-edge automation equipment.

Page Steel recently invested over \$3.5 million in robotic fabrication, increasing its capacity by up to 50% and future-proofing the business for the next ten years.

According to Director Chris Piacentini, Page Steel tackles larger projects. “We focus on industrial, commercial and government work—they are our three big sectors. We also target infrastructure work, as well as high-rise residential projects and multi-storey carparks. Our clients are generally tier one, two and three builders.”

EMBRACING AUTOMATION

“I really think what differentiates us is how we’ve embraced and tackled automation,” said Chris.

Page Steel has invested heavily in automation, from a high definition plasma machine (that can process plate up to 32mm thick, 3,000mm wide and 12,000mm long), and a CNC oxy cutter (that can process plates over 32mm thick), through to a fully automated CNC angle and plate line, and an automated section blaster with the ability to blast steel at Class 1 to Class 2.5.

AN INVESTMENT IN THE FUTURE

Page Steel recently purchased a Superior Single Rail Robotic Fabrication machine, which is capable of fabricating beams 1,100mm wide and 18,000mm long. The handling robot can pick up 250kg per add-on part and the beam weight has a maximum of 6 tonnes.

“The machinery we’ve invested in solves a lot of the issues we’ve been facing in terms of difficulty to recruit workers, accuracy and speed. There are so many pluses to the machine beside the initial investment.”



PACIFIC STEEL INCREASED PRODUCTIVITY AND CAPACITY VIA A SUPERIOR STRUCTURAL STEEL AUTOMATION FOR BEAM ASSEMBLY AND WELDING MACHINE

Pacific Steel Constructions is proud of its reputation for providing superior quality steel structures to the building and construction industries. The depth of expertise and vast experience of its four founders enable Pacific Steel to undertake complicated structures and state significant projects.

This expertise has been augmented recently, with their investment in a Superior Structural Steel Automation for Beam Assembly and Welding machine of which Specialist Machinery Sales is the exclusive agent for.

According to Nick Christou (Co-Founder, Pacific Steel Constructions), "This superior machine has opened up the capacity of our workshop. We can now take on multiple projects, all without increasing the size of our workforce or footprint. One of the main reasons we purchased this machine and partnered with SMS was to increase our output and our turnover while maintaining the same size workshop.

We don't have a large workshop, as it has limited floor space, and so we needed to maximise the efficiency of that entire area."

INCREASED QUALITY AND ACCURACY

"Regardless of how stringent your quality system is with conventional fabrication, errors can slip through. Inaccurate steelwork is very costly to repair on-site, causes construction schedule delays, and ultimately damages your reputation," said Christou.

INCREASED PRODUCTIVITY

"Without this superior machine, by the time a boilermaker does the beam marking out, manual handling and tacking, it would require at least 15 minutes per part. For more complex parts that are rotated on three planes, and require extensive setting out, the boilermaker may take up to one hour. Using the machine doesn't matter if the part is straight, or on a complex angle, the entire process takes the same amount of time."

PARTNERING WITH SMS

Todd has supported our workshop's ambition to automate the fabrication and welding of a steel fabrication business when commissioning this superior machine.

I can testify that the SMS partnership is reliable, authentic, passionate and honest when evaluating and supplying technology that future proofs our workshop, so we can win more and do more with less footprint and skilled labour.



DIAB ENGINEERING: PARTNERING WITH SMS

Diab Engineering located in Geraldton in Western Australia specialises in fabrication supplied to the resource recovery sector in WA. The workshop during COVID had sold their fabrication capacity for the next 9 months when metalworking packages were reshored from low labour cost countries that the miners were concerned with supply/schedule issues.

Diab ordered the Superior Structural Steel Automation Beam Assembly and Welding machine due to the COVID travel restrictions at the time did not travel to Europe or Australia to view any installations which isn't the way our business has historically purchased machinery.

This unique buying challenge for a high-value automated fabrication and welding machine meant our businesses needed to rely on the reputation of Todd from SMS plus the technology itself to perform with accuracy.

Diab Engineering obviously needed to rely on the testimonials of existing SMS clients in AU/NZ who were all very satisfied with their buying decision. The existing SMS clients had indicated that Todd was honorable in the way the technology was presented and could be trusted.

The evaluation process for the technology that Todd guided us through was robust so our team could identify where this superior machine would positively impact our workshops capacity to deliver fabricated steel accurately to tight schedules.

The machine delivery ran on time and the commissioning, training and after-sales service/support have been what was promised.

Diab can trust the technology that was provided to be accurate, efficient, safe and profitable for the businesses overall success.



DUNSTEEL INVESTS IN KALTENBACH SYSTEM

For more than 50 years has been, Dunsteel remains a proudly family-owned and operated business. Dunsteel specialises in complex projects for leading building firms and architects and is at the forefront of prefabricated stairway design for large multi-storey buildings.

According to Dunsteel's Director, Jonathon Dunlop, they invested in the Kaltenbach steel processing system, to help improve productivity and bolster efficiency.

INCREASED PRODUCTION

"Our ambition is to have the machine working two shifts per day—to load it up and then leave it alone. Depending on the complexity of the job, this outcome is achievable and does happen."

LAYOUT MARKING

By automating layout marking, the fabrication schedule can be improved by as much as 30 per cent, without increasing headcount or footprint. It also improves accuracy on-site, helping to eradicate rework.

EXTRA SERVICE

A couple of the extra features that Kaltenbach offered were the additional X-axis on the drilling line, allowing for multiple operations to be conducted at once, and a function called AFC (Automatic Feed Control) on the saw line that enables a pivoting action on the band saw," said Dunlop.

CUSTOMER SERVICE TO COUNT ON

"We chose to partner with Kaltenbach because we felt that their culture was a good fit with our 'family business' style of operating. Kaltenbach felt like a small, tightly managed organisation, as opposed to some of the other players in the market that are much bigger," said Dunlop.



HOW AUTOMATION DOUBLED ACA'S CAPACITY

Based in Ingleburn, New South Wales, Ace Construction Australia (ACA) specialises in architectural, structural general fabrication and installation.

Since the company's inception 15 years ago, ACA has earned a solid reputation for high-quality workmanship and expanded rapidly as a result.

To augment this expansion, ACA recently became the first company in New South Wales to invest in a Superior Coping Robot 3D Profile Plasma Cutting Machine, exclusively supplied by Specialist Machinery Sales.

This investment has doubled ACA's fabrication capacity, without increasing their footprint or headcount and helped to future proof the business profit from avoiding rework. According to Mohamed Elomar (General Manager, ACA), when he first established the company, the only automated machinery in the workshop was a saw, punch and shearing machine.

"We decided that to keep pace with the industry, we needed to invest in automation. So, we purchased a CNC machine. While this helped to augment our operations, we really wanted to move to a machine that could do it all—plasma cutting holes, on all profiles including SHS and RHS, complex coping and add-on-part layout marking without requiring re-work by the boilermaker."

THE RESULTS

ACA has doubled the capacity of their workshop. "Prior to the installation of the machine supplied by SMS, we produced 50 tonnes per week. Now we can produce 100 tonnes per week—all without increasing either our workforce or our footprint." This increased capacity means that ACA can meet clients' project timeframes much more easily, and is even able to sell their excess capacity to some of the local steel service centres.

"When tendering, I know I have a higher chance of winning projects now—everyone else is relying on traditional fabrication methods or traditional coping robots that require considerable rework for every profile. Our natural competitors cannot supply the same capacity, schedule, quality and man-hours per tonne. Partnering with SMS means that I win more work and increase my profits," said Elomar.



CIVMEC: PRODUCTION CAPACITY BROUGHT TO THE NEXT LEVEL WITH FOUR SMS SUPERIOR MACHINES

CIVMEC is an integrated multi-disciplinary heavy engineering and construction provider located in Henderson, Western Australia. They provide services to metals and minerals, oil and gas, infrastructure, water and energy, as well as marine and defence markets.

Fundamental to their strategy is their diverse range of capabilities that enables them to provide a large scale of complementary in-house core competencies and services including heavy engineering, modularisation, structural mechanical, piping and electrical.

CIVMEC is very on-point when it comes to innovation to improve the company's productivity and efficiency. That is why they have chosen to partner with Specialist Machinery Sales and invest in their superior machinery. "Originally a part of the reason why we bought the Superior 3D Profile Plasma Cutting and Coping Robot was that we wanted to be able to bevel box sections, which we weren't able to do previously".

"The Superior Cope Robot is a very good machine. We have utilised it at the end of our beamlines, so we got an automatic beamline. It gives us the ability to double-bevel the flanges on the beams, which previously we were not able to do."

The company was very pleased with its result and invested in three more machines in the span of 24 months. Now the company is a proud owner of 4 SMS superior machines - two Superior Pipe Cutting Machines, one Superior Robot Profile Cutting Line and the latest addition - one Superior Cope Robot which automates their cutting work.

"The fit-up is significantly less because we don't have to manually bevel plates, pipes or the beams. It is the correct coming off the machine. It reduces the number of man-hours associated with fit-ups for sure." David said.



SOUTHERN QUEENSLAND STEEL (SQS): " THERE'S NOT A PROFILE WE CAN'T CUT!"

Southern Queensland Steel (SQS) is a family-owned steel processing company from Queensland, Australia. Investing in the SMS RPC1200 beam cutting machine brought the company a competitive advantage: "There isn't a cut we can't make".

Due to the need for innovation, Southern Queensland Steel decided to expand their machinery with Superior Beam Cutting machine, exclusively supplied by Specialist Machinery Sales.

SQS is proud of the most recent innovation they brought to their facility. It is not only the high cut quality when cutting haunches, tapers or bevel, which makes SQS proud of its brand-new coping robot, but even more when it comes to the specials.

"We have a competitive advantage in the market", according to Teunissen. "There isn't a profile we can't process and produce a finished product on the first attempt".

THE RESULTS

Even the most complex of work that SQS throws at the SMS is produced with high quality and excellent accuracy.

Also cutting RHS around the corner and cutting flanges away to the web is being done with utmost accuracy on the Superior coping robot. This beam cutting machine helped Southern Queensland Steel to add even more value to their customers' steel.

The Superior Beam Cutting machine helped Southern Queensland Steel to add even more value to their customers' steel. "It helped us grow the business in the fact that we can now do everything", Thornton says. "The customer doesn't have the need to go anywhere else".

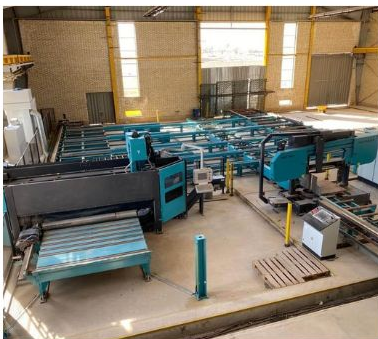

LOOKING TO BUY PRE-LOVED MACHINERY?

Specialist Machinery Sales offer second-hand or used structural steel processing machinery from Kaltenbach, Gietart, Haeusler, SLF and more.

Generally, the machines that SMS has access to are from trading for new machines offered from the machine tool builders to clients of SMS in Australia and New Zealand. Most machines are between 5 and 15 years of age with full-service history available. Some machines can be inspected under power or in their shipping packing ready for immediate delivery to Australasia.

[LEARN MORE HERE ▶](#)

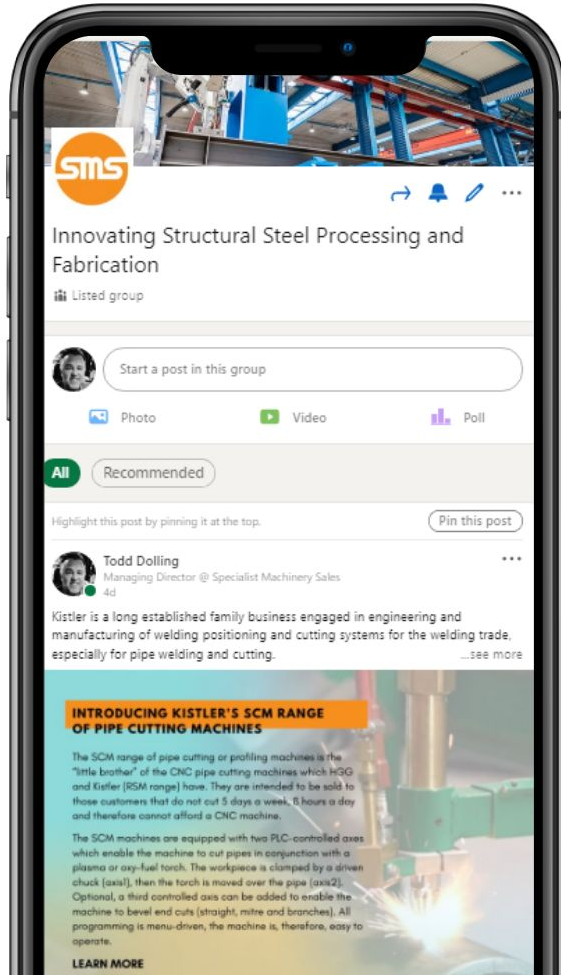

JOIN OUR EXCLUSIVE AND GROWING LINKEDIN GROUP

Join our growing and exclusive LinkedIn Group -
[Innovating Structural Steel Processing and Fabrication Group.](#)

In this group, we bring in thought leadership content, topics, trends and challenges within the steel industry and steel processing automation. We encourage everyone to share your business challenges and solutions that you have encountered and how steel processing automation had helped achieved your business objectives.

[JOIN HERE ▶](#)

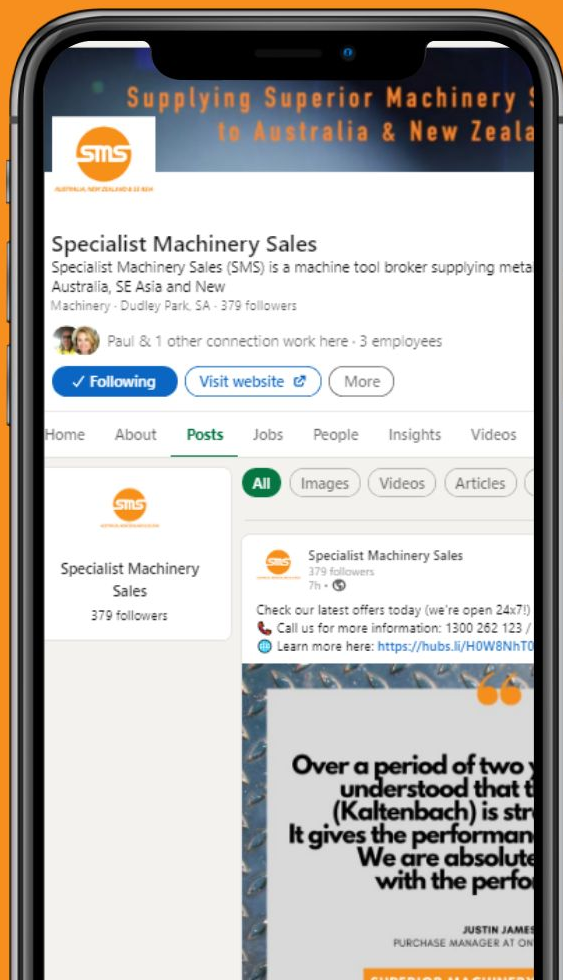

HATE MISSING OUT?

Be the first to receive the latest promotions, new releases and discounted offers by following us on social:





**SPECIALIST
MACHINERY
SALES**

AUSTRALIA, NEW ZEALAND & SE ASIA



1300 262 123 / +61 8 6500 6880



tellmemore@smsales.com.au
www.SMSales.com.au

